

GATX

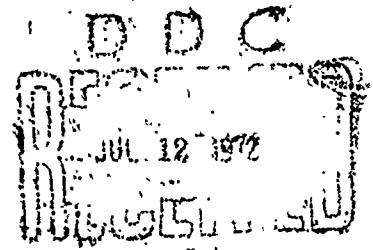

GENERAL AMERICAN TRANSPORTATION CORPORATION

AD 744789



GENERAL AMERICAN RESEARCH DIVISION

7448 NORTH NATCHEZ AVENUE, NILES, ILLINOIS 60848 312/847-8000

Reproduced by
**NATIONAL TECHNICAL
INFORMATION SERVICE**
U.S. Department of Commerce
Springfield, VA 22151

UNCLASSIFIED

Security Classification

DOCUMENT CONTROL DATA - R & D

(Security classification of title, body of abstract and indexing annotation must be entered when the overall report is classified)

1. ORIGINATING ACTIVITY (Corporate author) General American Research Division General American Transportation Corporation 7449 N. Natchez Ave., Niles, Illinois 60648	2a. REPORT SECURITY CLASSIFICATION Unclassified
	2b. GROUP

3. REPORT TITLE

BLAST VULNERABILITY OF SHELTER SUPPLIES

4. DESCRIPTIVE NOTES (Type of report and inclusive dates)
Final Report

5. AUTHOR(S) (First name, middle initial, last name)

Ajit L. Kapil

6. REPORT DATE February 1972	7a. TOTAL NO. OF PAGES 83	7b. NO. OF REFS 16
---------------------------------	------------------------------	-----------------------

8a. CONTRACT OR GRANT NO. D.HC20-71-C-0254 b. PROJECT NO. 1428A c. Shelter Research Division d. OCD Research Directorate	9a. ORIGINATOR'S REPORT NUMBER(S) 1518
	9b. OTHER REPORT NO(S) (Any other numbers that may be assigned this report)

10. DISTRIBUTION STATEMENT

This document has been approved for public release, distribution unlimited

11. SUPPLEMENTARY NOTES	12. SPONSORING MILITARY ACTIVITY Office of Civil Defense Office of the Secretary of the Army Washington, D. C. 20310
-------------------------	-------------------------------------------------------------------------------------------------------------------------------

13. ABSTRACT

This report describes the research in the areas of: 1) design improvement of the Kearny pump, 2) determination of the blast vulnerability of OCD-provided shelter supplies, and 3) applicability of large fan ventilators to shelters,

Recommendations include, among others; 1) suggestions regarding design changes in the Kearny pump to improve its fatigue life and resistance to blast waves, and 2) development of a practical production version of the large fan ventilator to reduce the overall cost of providing ventilation to NFSS basement shelters.

DD FORM 1473 1 NOV 65

REPLACES DD FORM 1473, 1 JAN 60, WHICH IS OBSOLETE FOR ARMY USE.

UNCLASSIFIED Security Classification

UNCLASSIFIED

Security Classification

14. KEY WORDS	LINK A		LINK B		LINK C	
	ROLE	WT	ROLE	WT	ROLE	WT
BLAST						
BLAST SHELTERS						
CONTAINERS						
COOLING & VENTILATING EQUIPMENT DAMAGE						
DEBRIS						
FALLOUT SHELTERS						
LIFE SUPPORT						
SHOCK WAVES						
VULNERABILITY						

Prepared for
Office of Civil Defense
Office of the Secretary of the Army
Washington, D. C. 20310

Summary of Report

BLAST VULNERABILITY OF SHELTER SUPPLIES

GARD Final Report 1518, March 1972

Contract No. DAHC20-71-C-0254
OCD Work Unit 1428A

Approved for Public Release;
Distribution Unlimited

by

A. L. Kapil

REVIEW NOTICE

This report has been reviewed in the Office of Civil Defense and approved for publication. Approval does not signify that the contents necessarily reflect the views and policies of the Office of Civil Defense.

Summary of Report

BLAST VULNERABILITY OF SHELTER SUPPLIES

The objectives of this study were threefold:

- 1) To improve the design of the Kearny pump (KP) flaps to prevent their disintegration, so that the KP could be used as a shelter ventilator or air distributor for a period of at least two weeks without breakdown.
- 2) To determine experimentally the blast vulnerability of OCD-provided shelter survival supplies in a simulated shelter to an incident blast wave of 5 psi overpressure, and to suggest preferential storage locations for these supplies within shelters to limit blast damage.
- 3) To determine the percentage of the basement shelters in the OCD national inventory of shelters in which large fan ventilators (LFV's) could be used more effectively than pedal ventilators (PV's); i.e., provide the same or greater air flow at a lower cost.

I. Kearny Pump Design Improvement

The Kearny pump is a manually-powered ventilating device intended for use in fallout shelters. It consists of a series of overlapping plastic flap valves mounted on a frame provided with a hinge attachment at the top for attachment to a horizontal support. When the frame is swung back-and-forth, the valves close during the power swing and open during the return, causing the air to move in the direction of the power swing.

Fatigue tests conducted on a double-section KP showed the overall design to be adequate, except for the bottom four flaps (of Ionomer plastic)

which shred at the lower corners. This shredding amounted to a loss in flap area of about 3% which, although small, resulted in a loss of air pumping capacity of the KP by about 25%.

The present investigation was undertaken to locate new materials, or develop new designs for the flaps, which would survive two weeks of continuous use. Based on the investigation, a reinforced polyester film (Griffolyn #55) was located which fulfills all requirements. Its cost is comparable to that of the Ionomer film.

II. Blast Loading and Response Studies of Shelter Supplies

The blast vulnerability of the following items were evaluated:

- 1) Pedal ventilator kit (PVK)
- 2) Kearny pump kit (KPK)
- 3) Cubical plastic dual-purpose water containers (DPC), 14-gallon capacity
- 4) OCD water containers, 17½-gallon capacity
- 5) Collapsible water container (CWC), 350-gallon capacity
- 6) Survival biscuit containers
- 7) Radiation kits
- 8) Sanitation kits, Type SK IV

The tests were conducted at the Shock Test Facility of the URS Research Company in a simulated shelter 16'5" long x 12'0" wide x 7'6" high. The incident blast overpressure was maintained at approximately 5 psi for all the tests; the positive phase duration varied between 100 and 140 msec. The blast was generated by detonation of Primacord. A series of four tests were conducted with the supplies in various locations and the simulated shelter in both dead-end and flow-through configurations. The major conclusions are the following:

- 1) The deployed Kearny pump will not survive an incident blast overpressure of 5 psi at the shelter entrance, even if placed in a protected location.
- 2) The deployed one-operator pedal ventilator when placed in protected locations, i.e., prevented from translating, will survive this blast overpressure.
- 3) The cubical plastic dual-purpose water container and the steel-wall collapsible water container are satisfactory at this blast overpressure.
- 4) The other OCD-provided supplies (radiation kits, water cans, survival biscuit containers, and sanitation kits) will withstand a 5 psi blast wave.
- 5) The packaging of all supplies is satisfactory.

III. Applicability of Large Fan Ventilators to Shelters

This study was based on ventilability analyses, using PV's and LFV's (60" diameter fan with shroud), of a sample of 239 basement shelters (GARD Sample) selected to represent the NFSS (National Fallout Shelter Survey) shelters, both in geometrical characteristics and shelter ventilation requirements. Experimentally obtained performance curves, i.e., the curves of static pressure vs. flowrate, for the PV and LFV were employed.

The results of the analyses which are applicable to the nationwide system of basement fallout shelters in the NFSS were the following:

- 1) Number of shelters ventilable by PV: 91.3%
- 2) Number of shelters ventilable by LFV: 51.4%
- 3) Number of shelters not ventilable by either PV or LFV: 8.7%
- 4) For a relative LFV to PV cost of \$1.50 to \$1.00 (a reasonable estimate):

- a) Shelters in which LFV's can be more advantageously used
(i.e., would be less expensive) than PV's: 34.3%
- b) Overall savings in cost compared to utilizing PV's only: 18.0%
- c) Optimum mix of PV to LFV: 2.7:1
- d) Reduction in the number of units procured for this mix as
compared to utilizing PV's only: 27.6%

From the above it can be concluded that if the LFV cost does not exceed 150% of the PV cost, the use of LFV's in 34.3% of the NFSS basement shelters would result in an overall savings of 18%.

Prepared for
Office of Civil Defense
Office of the Secretary of the Army
Washington, D. C. 20310

BLAST VULNERABILITY OF SHELTER SUPPLIES

GARD Final Report 1518, March 1972

Contract No. DAHC20-71-C-0254
OCD Work Unit 1428A

Approved for Public Release;
Distribution Unlimited

by

A. L. Kapil

REVIEW NOTICE

This report has been reviewed in the Office of Civil Defense and approved for publication. Approval does not signify that the contents necessarily reflect the views and policies of the Office of Civil Defense.

FOREWORD

This report was prepared by the General American Research Division, General American Transportation Corporation for the Office of Civil Defense under Contract DAHC20-71-C-0254, Work Unit 1428A. It covers the research performed between January 1971 and February 1972 in the following areas:

- 1) Design improvement of the Kearny pump
- 2) Determination of the blast vulnerability of OCD-provided shelter survival supplies, and
- 3) Applicability of large fan ventilators to shelters.

The author wishes to thank Mr. Robert G. Hahl of OCD for his invaluable assistance in helping to direct this effort; Messrs. Ken Kaplan, Chuck Wilton, Joe Boyes and Paul Kennedy, all of the URS Research Company, for their assistance in running the blast tests at their Shock Test Facility; and Mr. Carl E. Rathmann of GARD for his help in formulating the analytical approach used in the study of the application of large fan ventilators to shelters.

NOTE: The mention of any commercial product in this report does not constitute an endorsement or approval of that product by the Office of Civil Defense. Nor does it infer that there are not other products which might also meet the specifications

ABSTRACT

In this study, effort was directed at three tasks:

- 1) Design improvement of the Kearny pump to increase its fatigue life.
- 2) Evaluation of the blast vulnerability of shelter survival supplies, such as ventilators, water containers, biscuit containers, radiation kits, etc.
- 3) Applicability of large fan ventilators (60" diameter fans) to basement shelters.

The blast tests were conducted in a simulated shelter at the Shock Test Facility of the URS Research Company, with Primacord as the blast-generating explosive.

The major conclusions from the study are the following:

1) Kearny pump

The fatigue life of the Kearny pump can be increased by changing the material of the flaps.

2) Blast tests

- a) The deployed Kearny pump is not expected to survive an incident blast overpressure of 5 psi at the shelter entrance, even if placed in a protected location.
- b) The deployed one-operator pedal ventilator when placed in protected locations, i.e., prevented from transiting, will survive this blast overpressure.
- c) The cubical plastic dual-purpose water container and the steel-wall collapsible water container are satisfactory at this blast overpressure.
- d) The packaging of all supplies is satisfactory.

3) Large fan ventilator

If the large fan ventilator can be manufactured at 150% of the pedal ventilator cost (an achievable goal), it will be able to replace the latter in 34.3% of the nation's basement shelters at an overall savings in cost of 18%. This savings will be due to a reduction in the total number of units required.

The report includes detailed test results and appropriate recommendations.

TABLE OF CONTENTS

<u>SECTION</u>	<u>PAGE</u>
FOREWORD	i
ABSTRACT	ii
1 INTRODUCTION AND SUMMARY	1-1
1.1 Kearny Pump Design Improvement	1-1
1.2 Blast Loading and Response Studies of Shelter Supplies	1-2
1.3 Applicability of Large Fan Ventilators to Shelters	1-4
2 KEARNY PUMP DESIGN IMPROVEMENT	2-1
2.1 Flap Failure Evaluation	2-3
2.2 Material and Design Selection for Evaluation	2-3
2.3 Fatigue Test Setup and Test Results	2-3
3 BLAST LOADING AND RESPONSE STUDIES OF SHELTER SUPPLIES	3-1
3.1 Blast Test Facility	3-2
3.2 Test Shelter	3-4
3.3 Test Setup	3-4
3.3.1 Test 1	3-11
3.3.2 Test 2	3-18
3.3.3 Test 3	3-20
3.3.4 Test 4	3-24
3.4 Conclusions and Recommendations	3-24
4 APPLICABILITY OF LARGE FAN VENTILATORS TO SHELTERS	4-1
4.1 Study Approach	4-1
4.2 Shelter Air Flow Rate Computation for the Pedal Ventilator	4-6
4.3 Shelter Air Flow Rate Computation for the Large Fan Ventilator	4-8
4.4 Results, Conclusions and Recommendations	4-9
5 RECOMMENDATIONS	5-1
6 REFERENCES	6-1

APPENDIX A Pressure Profiles of Blast Tests

APPENDIX B GARD Sample Shelter Characteristics

LIST OF FIGURES

<u>FIGURE</u>		<u>PAGE</u>
2-1	Design Versions of the Kearny Pump	2-2
2-2	Original Design of Kearny Pump Flap Showing Fatigue Failure After One Week of Continuous Operation	2-4
2-3	Fatigue Test Setup	2-6
2-4	Flap Designs Evaluated	2-7
2-5	Cross Section of Tear Resistant Material Found Suitable for KP Flaps (Griffolyn #55)	2-9
3-1	Underground Shock Tunnel of URS Research Co.	3-3
3-2	Simulated Test Shelter in Shock Tunnel	3-5
3-3	Shelter Geometry and Survival Supply Locations For Blast Tests	3-6
3-4	Test 1 - Before Blast	3-16
3-5	Test 1 - After Blast	3-17
3-6	Test 2 - After Blast	3-21
3-7	Test 3 - Before Blast	3-22
3-8	Test 3 - After Blast	3-23
4-1	Large Fan Ventilator with Shroud	4-2
4-2	Ventilator Performance Curves for 0.1 Horsepower Input	4-3
4-3	GARD Sample of Basement Shelters	4-5

LIST OF TABLES

<u>TABLES</u>		<u>PAGE</u>
2-1	Kearny Pump Flap Evaluation	2-8
3-1	Military Specifications for PVK, KPK and CWC Packaging	3-8
3-2	Specification of PVK, KPK and CWC Packaging Used in Blast Tests	3-9
3-3	Size and Weight of Shelter Survival Supplies	3-10
3-4	Blast Test 1 - Peak Overpressures and Pressure Durations	3-12
3-5	Blast Test 2 - Peak Overpressures and Pressure Durations	3-13
3-6	Blast Test 3 - Peak Overpressures and Pressure Durations	3-14
3-7	Blast Test 4 - Peak Overpressures and Pressure Durations	3-15
3-8(a)	Gauge Measured Reflected Pressure (P(R)) Due to Incident Overpressure (P(I))	3-19
3-8(b)	Incident Overpressure (P(I)) Due to Gauge Measured Reflected Pressure (P(R))	3-19
4-1	Length Equivalent (L_b) for Constrictions of 30-Inch Polyethylene Duct	4-7
4-2	GARD Shelter Sample, Number of PVK's or LFV's Required to Fully Ventilate Shelters	4-10
4-3	GARD Shelter Sample, Shelters Ventilable by Both PVK and LFV	4-11
4-4(a)	GARD Shelter Sample, Relative Ventilation Cost Analysis PVK Cost 1.00	4-12
4-4(b)	GARD Shelter Sample, Relative Ventilation Cost Analysis PVK cost 1.00	4-13

SECTION 1

INTRODUCTION AND SUMMARY

The objectives of this study were threefold:

- 1) To improve the design of the Kearny pump (KP) flaps to prevent their disintegration, so that the KP could be used as a shelter ventilator or air distributor for a period of at least two weeks without breakdown.
- 2) To determine experimentally the blast vulnerability of OCD-provided shelter survival supplies in a simulated shelter to an incident blast wave of 5 psi overpressure, and to suggest preferential storage locations for these supplies within shelters to limit blast damage.
- 3) To determine the percentage of the basement shelters in the OCD national inventory of shelters in which large fan ventilators (LFV's) could be used more effectively than pedal ventilators (PV's); i.e., provide the same or greater air flow at a lower cost.

1.1 Kearny Pump Design Improvement

The Kearny pump is a manually-powered ventilating device intended for use in fallout shelters. It is designed to move air essentially unidirectionally at low pressure heads, without the use of ducts. It consists of a series of overlapping plastic flap valves mounted on a frame provided with a hinge arrangement at the top for attachment to a horizontal support. When the frame is swung back-and-forth, the valves close during the power swing and open during the return, causing the air to move in the direction of the power swing.

As part of the design evaluation of the KP, prototype units were subjected to continuous two-week fatigue tests. These tests showed the overall

design to be adequate, except for the bottom four flaps (of Ionomer plastic) which shred at the lower corners. This shredding amounted to a loss in flap area of about 3% which, although small, resulted in a loss of air pumping capacity of the KP by about 25%.

The present investigation was undertaken to locate new materials, or develop new designs for the flaps, which would survive two weeks of continuous use. Based on the investigation, a reinforced polyester film (Griffolyn #55), was located which fulfills all requirements. Its cost is comparable to that of the Ionomer film.

1.2 Blast Loading and Response Studies of Shelter Supplies

The blast vulnerability of the following items were evaluated:

- 1) Pedal ventilator kit (PVK)
- 2) Kearny pump kit (KPK)
- 3) Cubical plastic dual-purpose water containers (DPC), 14-gallon capacity
- 4) OCD water containers, 17½-gallon capacity
- 5) Collapsible water container (CWC), 350-gallon capacity
- 6) Survival biscuit containers
- 7) Radiation kits
- 8) Sanitation kits, Type SK IV

The tests were conducted at the Shock Test Facility of the URS Research Company in a simulated shelter 16'5" long x 12'0" wide x 7'6" high. The incident blast overpressure was maintained at approximately 5 psi for all the tests; the positive phase duration was determined by the constraints of the test facility and the geometry of the simulated test shelter and varied between 100 and 140 msec. The blast wave was generated in the shock tube by means of the volume detonation technique with Primacord as the explosive material. A series of four tests was conducted with the supplies in various

locations and the simulated shelter in both dead-end and flow-through configurations. The major results and conclusions are the following:

- 1) The Kearny pump as designed is not expected to survive peak incident overpressures as high as 5 psi.* It was almost completely destroyed when tested in the deployed state at this overpressure. In addition, translation of debris from the damaged KP can cause serious injuries to the shelterees; a few of the flap hinge wires were found imbedded in the concrete walls and ceilings of the test shelter after the test and required a fair amount of force to remove. However, the packaged KP was unaffected by the blast.

Based on these results it is recommended that alternate methods of hinging the flaps to the frame (as, for example, by using nylon cord rather than metal wire), and more positive methods of assembling the components of the A-frame, should be investigated. In addition, double stocking of the KPK should be considered so that a second KP is available if the first is destroyed by blast. No change in the packaging of the KP is recommended.

- 2) The pedal ventilator as designed and set up in "protected" locations is satisfactory at blast overpressures of 5 psi. The packaging although torn in the tests is considered adequate for the application. No change in the PV design or packaging is recommended.
- 3) Filled and stacked cubical plastic dual-purpose water containers were found to be very stable. In no test were they moved from their

* It should be noted that the tests were run with an incident blast overpressure of approximately 5 psi at the entrance to the simulated shelter. To achieve this overpressure at the entrance of an actual basement shelter, the ambient (ground level) overpressure will have to be considerably higher, perhaps more than twice as high. This higher overpressure should be considered when correlating the results with weapon size.

original position as a result of the blast, and as a consequence none of the stored water was lost.

The DPC's are recommended for shelter use.

- 4) The steel-wall collapsible water container (350-gallon capacity) has adequate strength to withstand a 5 psi overpressure blast wave when deployed. About 10% of the water was lost because the container protective cover was blown off just prior to a transient deformation of the CWC by the blast. To reduce this loss, it is recommended that positive methods for anchoring the cover to the container be investigated.
- 5) The other OCD-provided supplies (radiation kits, water cans, survival biscuit containers and sanitation kits) were undamaged by the 5 psi blast wave and appear to be adequately packaged.

1.3 Applicability of Large Fan Ventilators to Shelters

This study was based on ventilability analyses, using PV's and LFV's (60" diameter fan with shroud), of a sample of 239 basement shelters (GARD Sample) selected to represent the NFSS (National Fallout Shelter Survey) shelters, both in geometrical characteristics and shelter ventilation requirements. Experimentally obtained performance curves, i.e., the curves of static pressure vs. flowrate, for the PV and LFV were employed.

The results of the analyses which are applicable to the nationwide system of basement fallout shelters in the NFSS were the following:

- 1) Number of shelters ventilable by PV: 91.3%
- 2) Number of shelters ventilable by LFV: 51.4%
- 3) Number of shelters not ventilable by either PV or LFV: 8.7%
- 4) For a relative LFV to PV cost of \$1.50 to \$1.00 (a reasonable estimate):
 - a) Shelters in which LFV's can be more advantageously used (i.e.,

would be less expensive) than PV's: 34.3%

- b) Overall savings in cost compared to utilizing PV's only: 18.0%
- c) Optimum mix of PV to LFV: 2.7:1
- d) Reduction in the number of units procured for this mix as compared to utilizing PV's only:* 27.6%

From the above it can be concluded that if the LFV cost does not exceed 150% of the PV cost, the use of LFV's in 34.3% of the NFSS basement shelters would result in an overall savings of 18%.

* Each PV or LFV is considered a single unit.

SECTION 2

KEARNY PUMP DESIGN IMPROVEMENT

The Kearny pump (KP) is a manually-powered ventilating device intended for use within fallout shelters. It moves air essentially unidirectionally at low pressure heads, without the use of ducts. It can be employed for either ventilating small rooms or for distributing air within large rooms when used in conjunction with pedal ventilators (PV).

The Kearny pump consists of a series of overlapping plastic flap valves mounted on a frame provided with a hinge arrangement at the top for attaching to a horizontal support (Fig. 2-1). When the frame is swung back-and-forth, the valves close during the power swing and open during the return, causing the air to move in the direction of the power swing.

The design of the Kearny pump and its evaluation as a potential shelter ventilator, or air distributor, have been reported previously (Ref. 9 and 13). As part of the design evaluation for shelter use, prototype KP's were subjected to continuous two-week fatigue tests. These tests showed the overall design to be adequate, except for the bottom four flaps of the double-section KP, which shred at the lower corners. This shredding amounted to a loss in flap area of about 3% * which although small, resulted in a loss of air pumping capacity of the KP by about 25% (Ref. 14, pp 4-4, 4-5).

The present investigation was undertaken to locate new materials, or develop new designs for the flaps, which would survive two weeks of continuous use.

* Expressed as a percentage of the overall KP frame area.

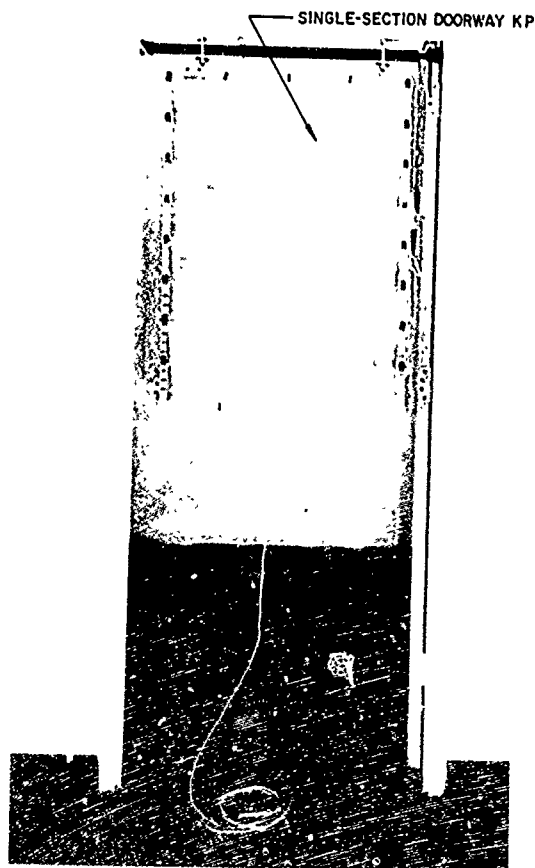
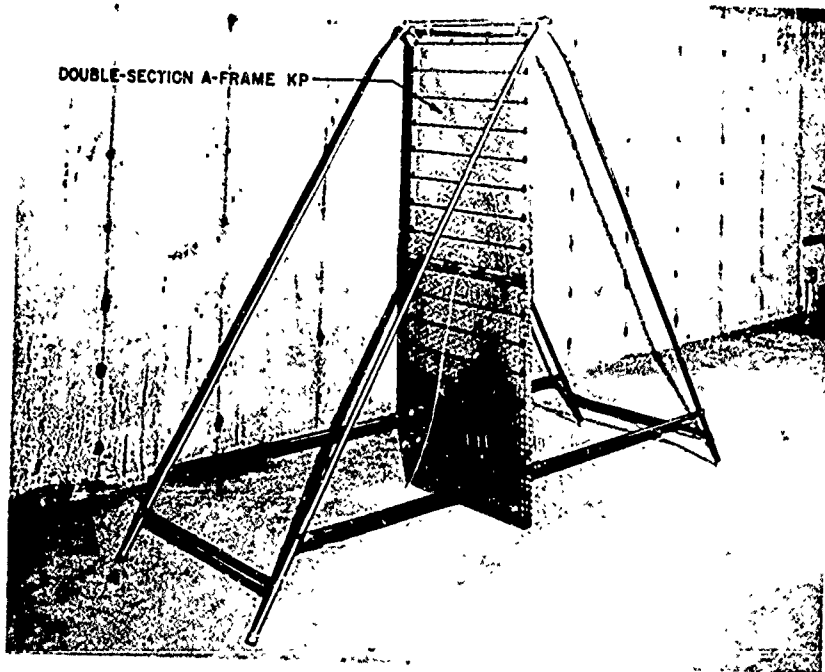

Figure 2-1 Design Versions of the Kearny Pump

2.1 Flap Failure Evaluation

The original flaps were fabricated from Ionomer film.* The hem was formed by heat sealing, with the heat sealing parameters of clamp time, sealing temperature and sealing pressure being determined empirically to give a strong heat seal (Ref. 2).

The failures during the fatigue tests resulted from initiation of tear just below the heat sealed area and propagation of this tear downwards, leading eventually to a loss of the corners (Fig. 2-2). The tear initiation was judged to be due to local weakening of the material in the neighborhood of the heat seal.

2.2 Material and Design Selection for Evaluation

To locate a material suitable for the KP flaps, a literature search was conducted covering all potential unreinforced and reinforced plastic film materials. Based on this, the following three materials were selected for evaluation:

- 1) Ionomer film, 0.005 in. thick
- 2) Polyester film, reinforced, 0.004 in. thick
- 3) Vinyl film, 0.005 in. thick

The ionomer film was selected again, since it was judged to have intrinsically good mechanical and physical properties, and it was hoped that perhaps with some flap design changes it would prove adequate.

2.3 Fatigue Test Setup and Test Results

For the fatigue tests a double-section KP was selected since the lower-most flaps of the KP are subject to maximum wear and consequently fail.

* A class of thermoplastic polymers in which ionized carboxyl groups create ionic crosslinks in the intermolecular structure. These polymers are characterized by low density, high transparency, toughness, flexibility, resilience, and resistance to greases and organic solvents.

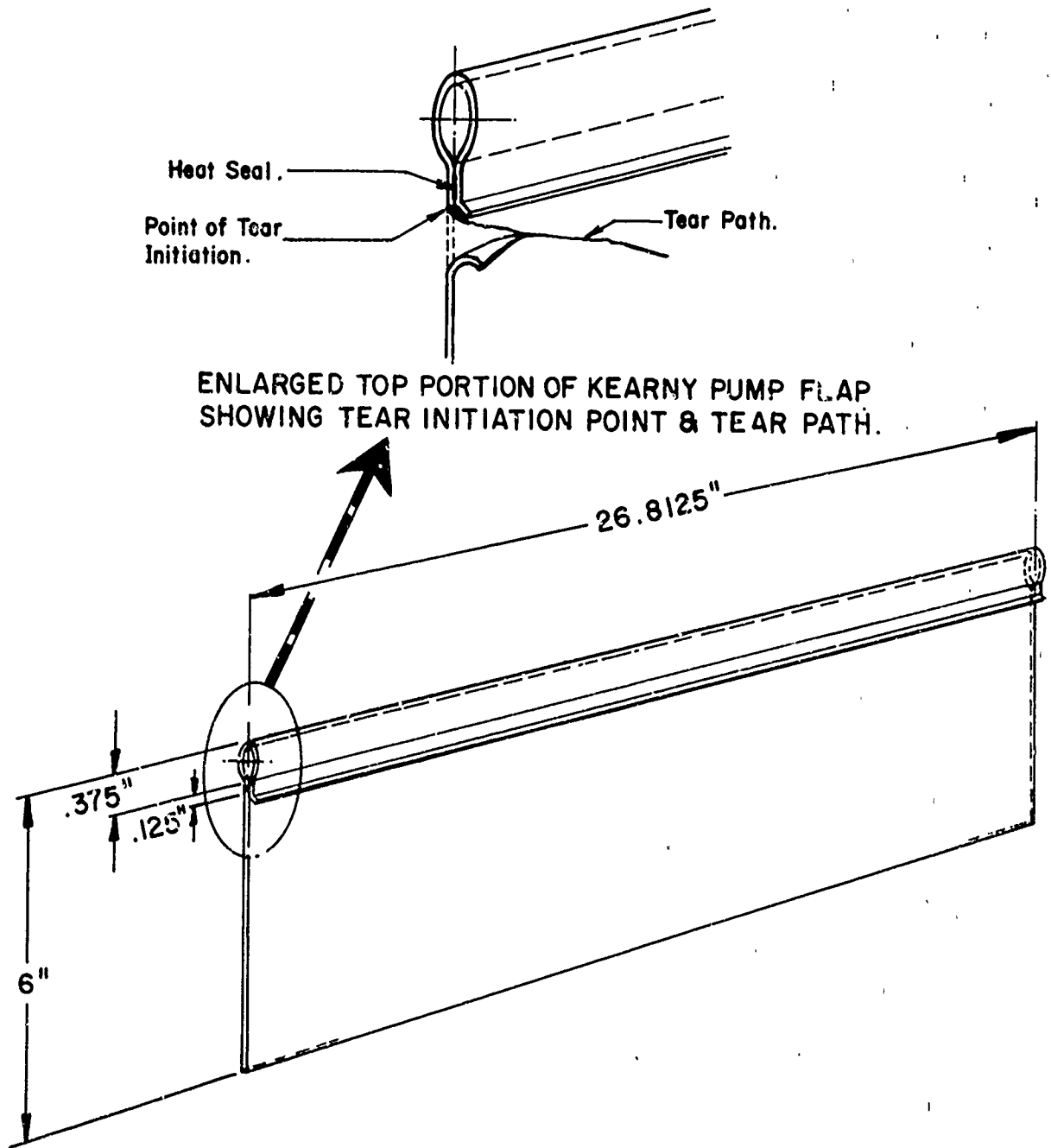

Figure 2-2 Original Design of Kearny Pump Flap Showing Fatigue Failure After One Week of Continuous Operation

The test setup is shown in Figure 2-3. The KP was operated by an oscillating drive mechanism which simulated the manual pulling action; the speed of the mechanism was adjusted to coincide with the damped natural frequency of oscillation of the KP (≈ 29 cpm) to prevent jerking and thus placing of abnormal stresses on the flaps.

Three designs of the flaps were evaluated (Fig. 2-4):

- 1.) Heat sealed hem (same as the original design)
- 2.) Interlocking stitch hem (to avoid heat sealing and thus weakening of the material)
 - a) Six to eight stitches per inch
 - b) Polyester thread
 - c) Backstitching at ends of flap to avoid unraveling
 - d) Stitching stopped 1/8-inch from ends to reduce possibility of tear initiation
- 3.) Heat sealed hem with sides doubled and heat sealed (to reduce possibility of tear initiation).

The results of the fatigue tests are summarized in Table 2-1. This table gives the material-design combinations evaluated, the duration and results of the tests, the cost analysis for each combination, and the relative rating of the different material-design combinations. The results show that of the five material-design combination evaluated, the least-cost combination which is satisfactory for the KP is the reinforced polyester film (Griffolyn #55, Fig. 2-5, and Ref. 10) with a heat sealed hem.*

* The criteria of a material being "satisfactory" was established as no tearing or shredding of a flap of the material, when mounted in the lower-most position of a double-section KP, and the KP operated continuously for two weeks.

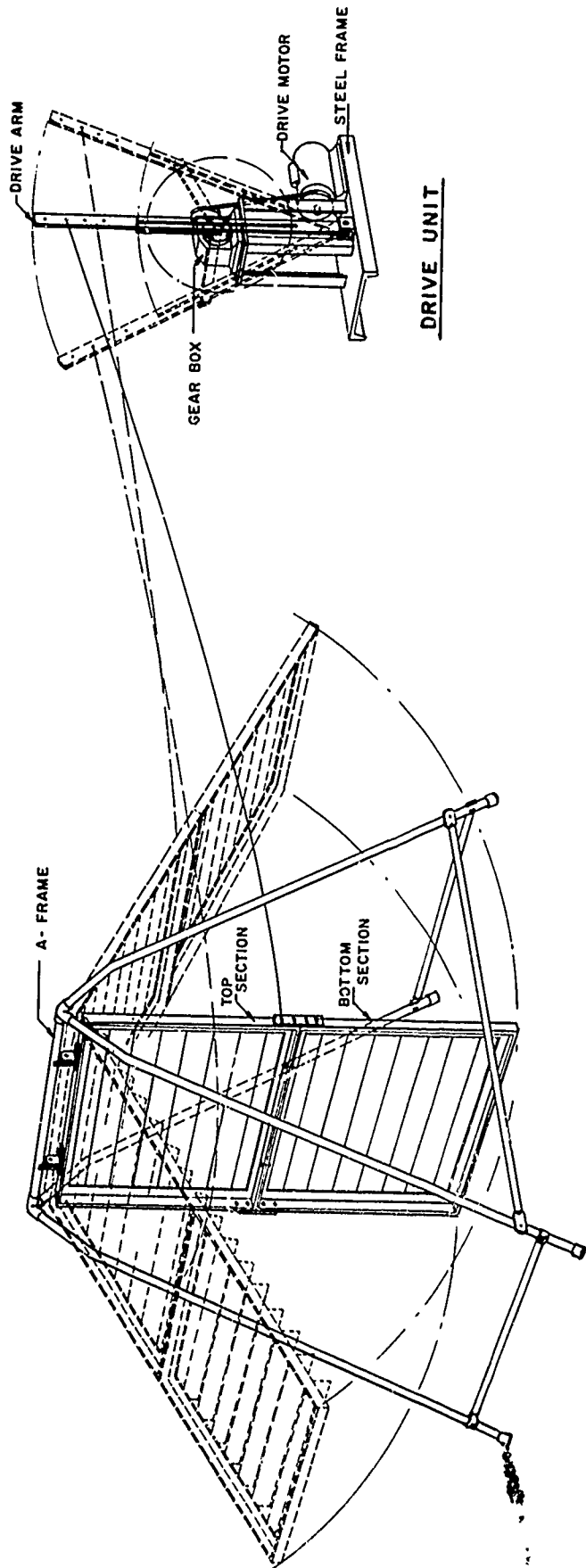

DOUBLE - SECTION KEARNY PUMP MOUNTED IN A - FRAME

Figure 2-3 Fatigue Test Setup

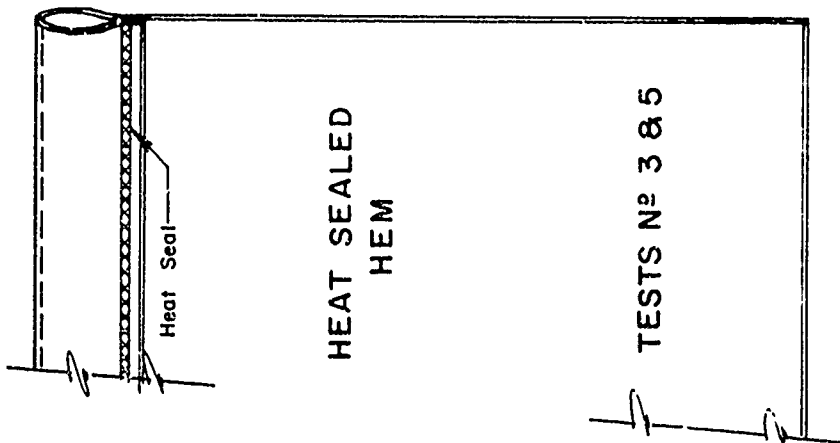
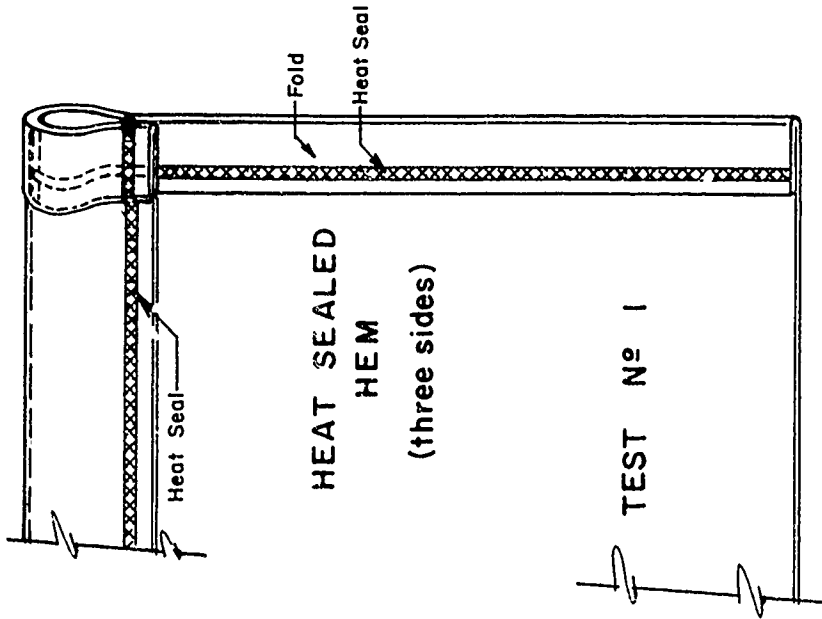
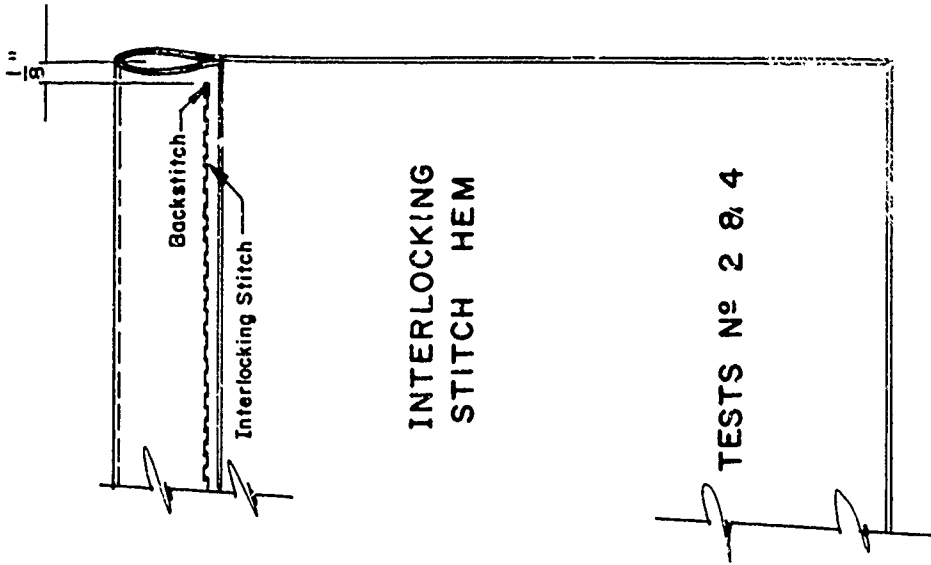

Figure 2-4 Flap Designs Evaluated

Table 2-1

Kearny Pump Flap Evaluation

Test No.	Flap Material			Item Design	Test Results			Flap Cost Analysis				Relative Rating **	
	Generic Type	Manufacturer	Grade		Test Duration	No. of Flaps Damaged *	Flap Area Lost per KP in. ² %**	Material Cost \$/ft ²	Material Fabrication \$	Cost Per KP	Total \$		
1	Ionomer Film	Floco-C-Clasco, Inc. Chicago, Ill.	SF71-C,*** Clear, .005 in.	Heat-Sealed 3 edges	8 days 3-1/2 hours	3	115.1	5.4	0.01	0.31	1.170	1.641	5
2	Ionomer Film	Floco-C-Clasco, Inc. Chicago, Ill.	SF71-C,*** Clear, .005 in.	Interlocking Stitch	21 days "	0	0	0	0.01	0.371	1.520	1.671	2
3	Polyester Film, Reinforced	Griffith Polym. Co., Inc. Houston, Texas	Griffith Polym # 55, Clear, .004 in. (Nominal)	Heat-Sealed	13 days 20-1/2 hours	0	0	0	0.030	0.585	0.735	1.320	1
4	Polyester Film, Reinforced	Griffith Polym Co., Inc. Houston, Texas	Griffith Polym # 55, Clear, .004 in. (Nominal)	Interlocking Stitch	21 days hours	0	0	0	0.030	0.565	1.500	2.065	3
5	Vinyl Film, Cast	Dayco Corp. Howell, Mich.	Castco C-254, .005 in.	Heat-Sealed	15 days 1-1/2 hours	2	50.7	2.4	0.032	0.24	0.735	1.350	4

* Sixteen flaps per full KP.
 ** Expressed as a percentage of the overall flame area of the full KP.
 *** Same as Grade 701 mentioned in Ref. 1, p. 5-10.
 + For approximately 1.5 ft² of the material.
 ** Highest rating: 1; lowest: 5.

Bonded Polyester Films
(Each .002 in. thick)

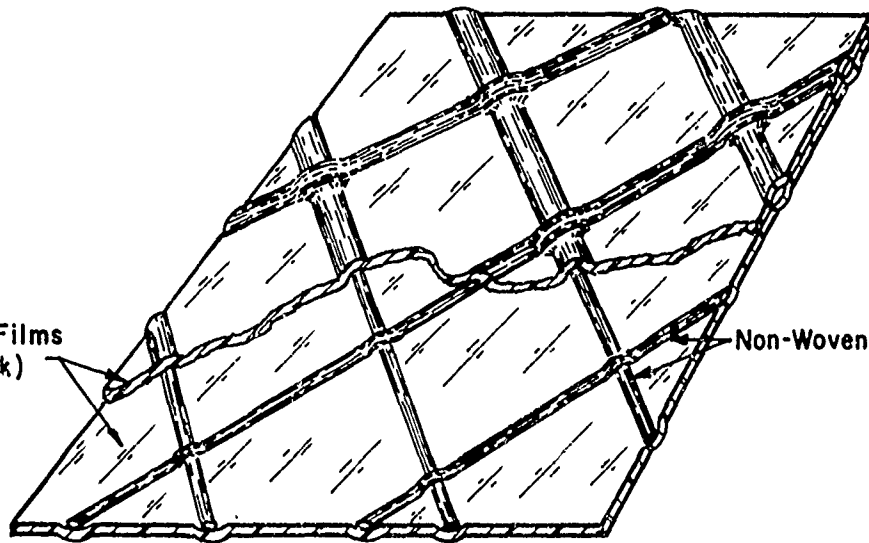

Non-Woven Reinforcing Fibers

Figure 2-5 Cross Section of Tear Resistant Material
Found Suitable for KP Flaps (Griffolyn #55)

Flaps of this type will cost \$1.32 per double-section KP * as compared to \$1.11 for the present Ionomer type and are recommended for use in the KP.

* In production lots of 2,000 KP units.

SECTION 3

BLAST LOADING AND RESPONSE STUDIES OF SHELTER SUPPLIES

The purpose of this study was to conduct full-scale experiments to determine the effects of a blast environment within basement fallout shelters on portable ventilators, water storage containers, and other OCD-provided shelter survival supplies. An additional purpose was to recommend preferred storage locations within the shelters for these supplies so that damage by blast may be limited or possibly prevented.*

The blast vulnerability of the following items were evaluated during the tests:

- 1) Pedal ventilator kit (PVK)
- 2) Kearny pump kit (KPK)
- 3) Dual purpose water containers (DPC), 14-gallon capacity
- 4) OCD water containers, 17½-gallon capacity
- 5) Collapsible water container (CWC), 350-gallon capacity
- 6) Survival biscuit containers
- 7) Radiation kits
- 8) Sanitation kits, Type SK IV

The incident blast overpressure was approximately 5 psi for all the tests; the positive phase duration was determined by the constraints of the test facility and the geometry of the simulated test shelter and varied between 100 and 140 msec. The incident blast overpressures were limited to 5 psi because pressures higher than this were considered unrealistic; few structures, if any, having fallout shelters, are likely to withstand incident overpressures that will cause basement incident overpressures greater than 5 psi.

* Previous studies by GARD on direct exposure of shelter ventilators to blasts are given in References 8 and 9.

3.1 Blast Test Facility

The blast loading and response study of the shelter supplies was a cooperative effort between GARD and the URS Research Company, and was conducted at the latter's Shock Test Facility located at Ft. Cronkhite, north of San Francisco. This facility is underground, in a former coastal defense gun emplacement complex, and contains a rectangular shock tunnel, approximately 163 ft. long (Fig. 3-1 and Ref. 15). The first 63 ft of the tunnel is used as a compression chamber and has an 8'0" x 8'6" cross section. The remaining tunnel then expands in an 8-ft transition section to an 8'6" x 12'0" cross section 92-ft long (the 12-ft dimension being horizontal). This portion of the tunnel is used as the expansion chamber. The walls of the tunnel are of reinforced concrete 3'0" to 12'0" thick; the roof is also of reinforced concrete, 6'0" to 16'0" thick.

The tunnel is operated as a shock tube by means of the volume detonation technique, with Primacord* as the explosive material. In this method of operation, strands of Primacord are placed axially within the compression chamber of the tunnel along its entire length. On detonation of the Primacord, a quasi-static pressure is very rapidly built up through out the entire compression chamber, and the expansion of this high pressure gas into the remaining part of the tunnel generates the desired shock wave.

Unlike conventional compressed-gas shock tubes, the compression and expansion chambers are not separated by a frangible diaphragm. The detonation of the Primacord is sufficiently rapid that the pressure build up in the

* Primacord is a detonating (exploding) cord consisting of the explosive PETN (pentaerythritol tetranitrate) encased in a textile braid and covered with various materials to provide strength and waterproofing (Ref. 3). When initiated by a blasting cap, it detonates along its entire length at a velocity of approximately 21,000 ft/sec.

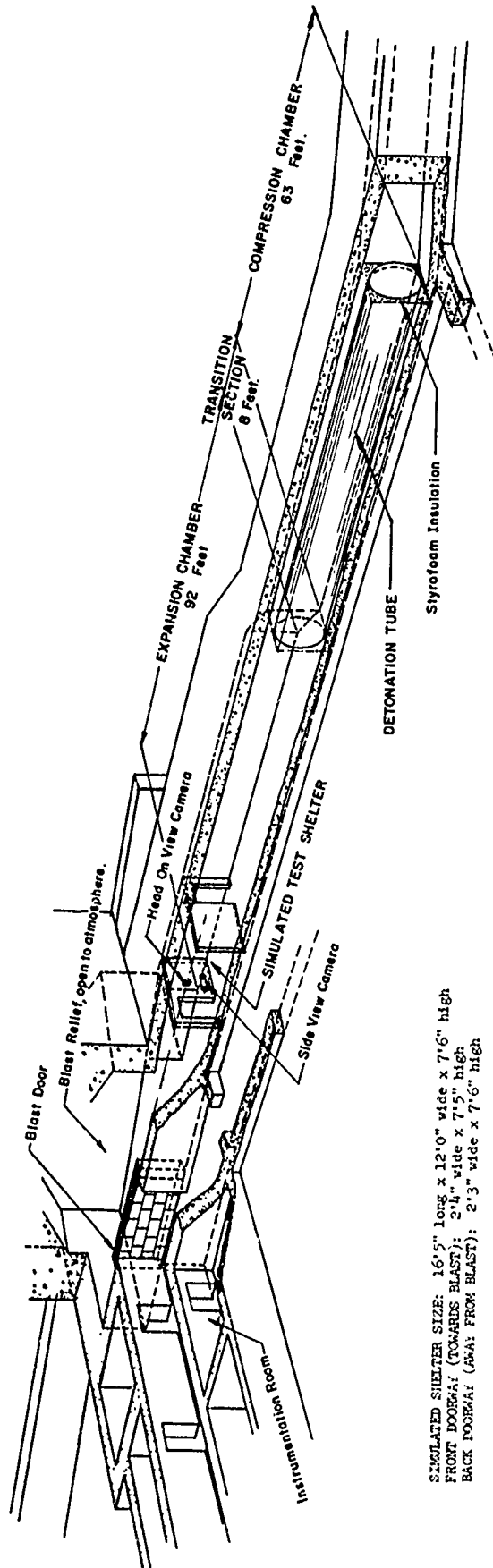

SIMULATED SHELTER SIZE: 16'5" long x 12'0" wide x 7'6" high
 FRONT DOORWAY (TOWARDS BLAST): 2'11" wide x 7'5" high
 BACK DOORWAY (AWAY FROM BLAST): 2'3" wide x 7'6" high

Figure 3-1 Underground Shock Tunnel of URS Research Co.

compression chamber is almost unaffected by the small expansion of the gases in the compression chamber during the build up period.

3.2 Test Shelter

The tests were conducted in a simulated shelter 16'5" long x 12'0" wide x 7'6" high, constructed within the expansion portion of the shock tunnel (Fig. 3-2). The shelter was located at the exit end of the expansion tunnel to get the maximum "flat-topped" pressure pulse (determined by previous experiments).

The shelter was provided with two non-failing walls and three removable doors. With this arrangement the test area could be made into either a dead-end or a flow-through shelter. A total of 10 pressure transducers was provided - four on the front wall, three on the back wall and three on the side wall (Fig. 3-2)*. With this arrangement the blast incident and reflected overpressures within the test area were measured at sufficiently dispersed locations to give a good indication of the pressure-time histories within the test shelter.

Viewing ports were also provided in two walls for taking high-speed motion pictures with 16 mm Fastax and Hycam cameras. The room was illuminated during the tests with floodlights (total wattage, 18,000) to allow sufficient details to be photographed.

3.3 Test Setup

A series of four tests was conducted, two with the simulated shelter in a dead-end configuration and two with the shelter in a flow-through configuration (Fig. 3-3). The items in each test were the following:

* The pressure transducers were connected through individual D. C. amplifiers (CEC 1-165) to a multichannel, FM, magnetic-tape data recorder (CEC VR-3300). Pressure traces were obtained by playback through a light-beam writing oscillograph (Honeywell, Visicorder, Model 1508A).

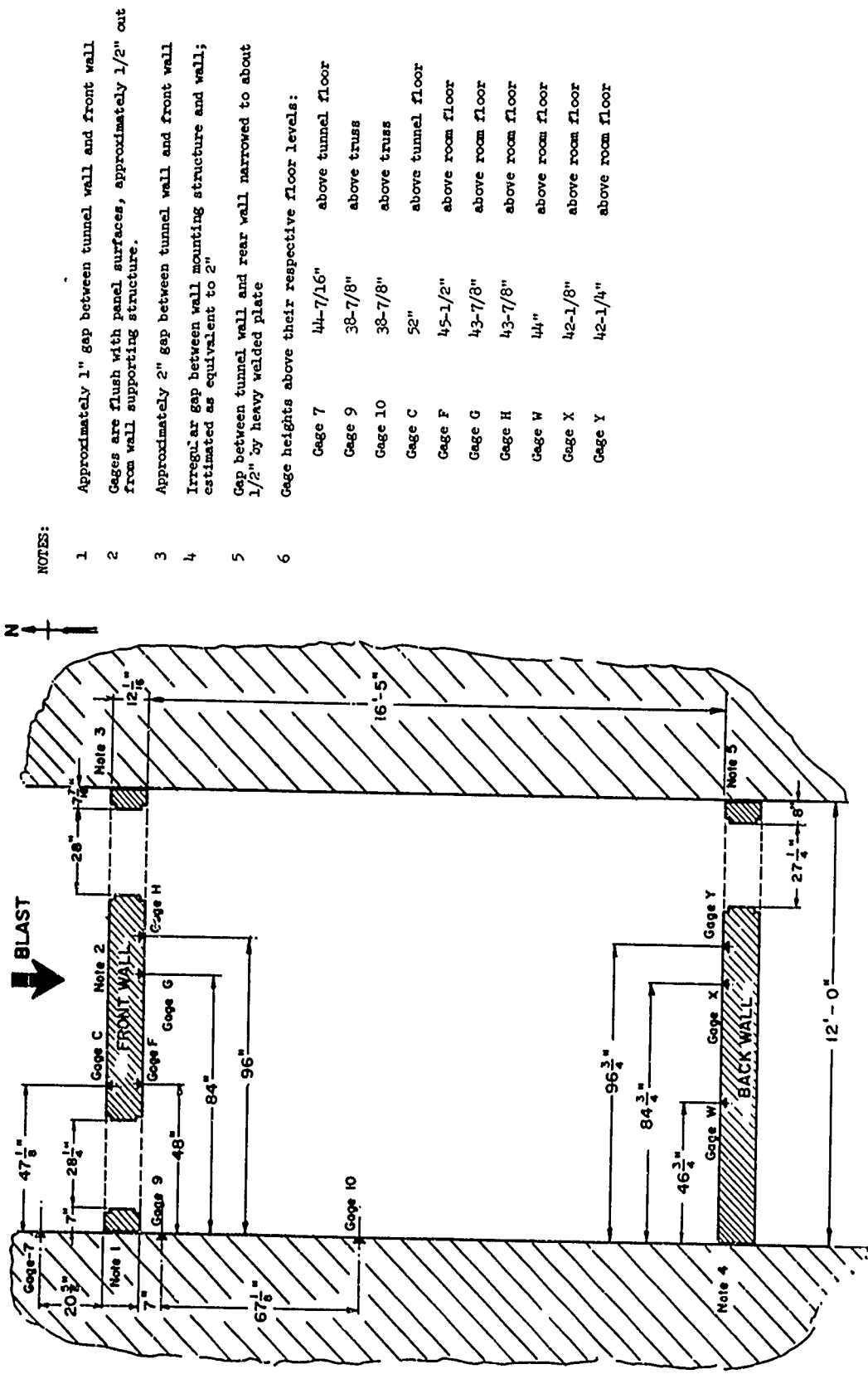

NOTES:

- 1 Approximately 1" gap between tunnel wall and front wall
- 2 Gages are flush with panel surfaces, approximately 1/2" out from wall supporting structure.
- 3 Approximately 2" gap between tunnel wall and front wall
- 4 Irregular gap between wall mounting structure and wall; estimated as equivalent to 2"
- 5 Gap between tunnel wall and rear wall narrowed to about 1/2" by heavy welded plate
- 6 Gage heights above their respective floor levels:

Gage 7	44-7/16"	above tunnel floor
Gage 9	38-7/8"	above truss
Gage 10	38-7/8"	above truss
Gage C	52"	above tunnel floor
Gage F	45-1/2"	above room floor
Gage G	43-7/8"	above room floor
Gage H	43-7/8"	above room floor
Gage W	44"	above room floor
Gage X	42-1/8"	above room floor
Gage Y	42-1/4"	above room floor

SHELTER PLAN VIEW

Figure 3-2 Simulated Test Shelter in Shock Tunnel

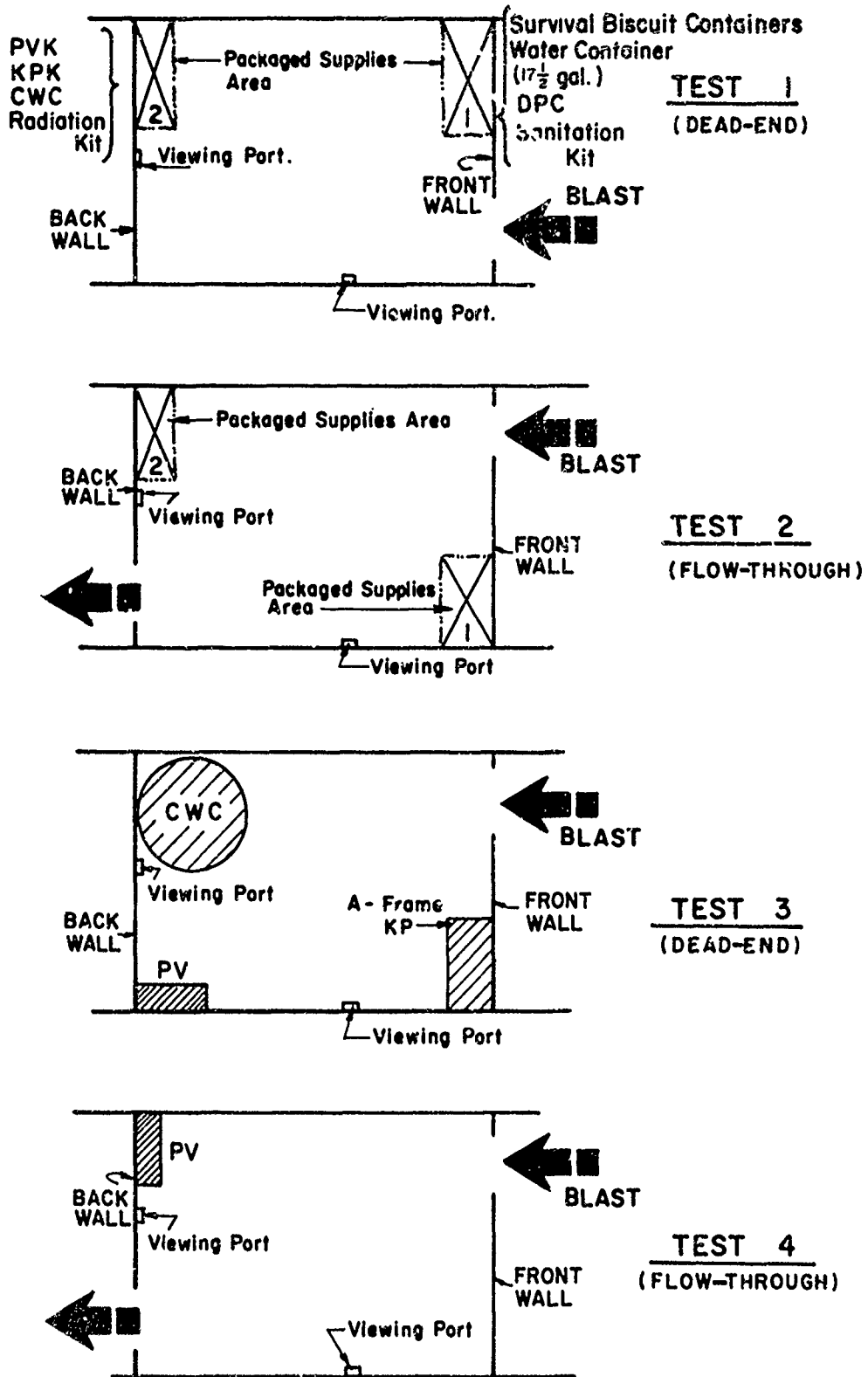

Figure 3-3 Shelter Geometry and Survival Supply Locations For Blast Tests

<u>Test</u>	<u>Room Configuration</u>	<u>Items (Qty.)</u>
1	Dead-end	Packaged PVK (1) Packaged KPK (1)* Packaged CWC's (1 steel-wall & 1 inflatable-wall) Packaged Radiation Kits (2) Packaged Survival Biscuit Containers (6) Packaged Sanitation Kits (2) Deployed DPC's (4)** Deployed OCD Water Containers (4)
2	Flow-through	Same as in Test 1
3	Dead-end	Deployed One-operator PV (1) Deployed A-frame KP (1) Deployed Steel-wall CWC (1)
4	Flow-through	Deployed One-operator PV (1)

In order to obtain realistic results on the packaged ventilators and CWC's it is necessary to package them in cartons meeting the requirements of their respective military specifications. Table 3-1 gives these requirements for the PVK, KPK and CWC's but were, however, not utilized because of the excessive manufacturing costs for the one or two pieces needed, and the long procurement lead time required. Easily available standard cartons of equivalent strength (although not of the same weather resistant quality) were used instead (Table 3-2). It is believed that the results obtained using the latter are similar to what would have been obtained, had the mil spec cartons been used. The overall sizes and weights of the various packaged items are given in Table 3-3. All of the packaged items are considered to be more sensitive to drag

* The KPK is packed in two separate boxes (Ref. 8, Appendix B).

** By "deployed" is meant items removed from packaging and made ready for use, although not necessarily placed at locations required for use.

Table 3-1
 Military Specifications for PVK, KFK and CWC Packaging

Qty.	Application	Style	Type	Class	Variety	Grade	Conforming to Spec.	Inside Dimensions			Note
								Length (in.)	Width (in.)	Depth (in.)	
1	PVK Duct Box	FPF	CF	Domestic	SW	125	PPP-B-636	48-1/2	4-3/8	4-3/8	
1	PVK Small Accessories Box	RSC	CF	Domestic	SW	125	Commercial Standards	6-1/2	6-1/2	3-1/2	
1	PVK Interior Box	FOL	CF	Domestic	SW	200	PPP-B-636	59-1/4	17-1/4	37-1/4	
1	PVK Exterior Box	OSC	SWCFI	I		275	PPP-B-1163	59-3/4	17-3/4	37-3/4	Must be capable of containing PVK Interior Box
2	Doorway Support Bar Box	FPF	CF	Domestic	SW	125	PPP-B-636	30-1/4	4-3/4	2	
2	Kearny Pump Interior Box	FOL	CF	Domestic	SW	125	PPP-B-636	30-3/4	5	41	
2	KPK Box A	OSC	SWCFI	I		250	PPP-B-1163	31-3/4	5-1/2	42	Must be capable of containing KP Interior Box
2	A-Frame Interior Box	FOL	CF	Domestic	SW	125	PPP-B-636	5	5	55	
2	KPK Box B	OSC	SWCFI	Domestic		200	PPP-B-1163	5-1/2	5-1/2	96	Must be capable of containing A-Frame Interior Box
4	Type A - CWC Interior Box	RSC	CF	Domestic	SW	200	PPP-B-636	24	20	6-1/4	
4	Type A - CWC Exterior Box	OSC	DACFI			275	PPP-B-1163	24-1/2	6-3/4	20-1/2	Must be capable of containing Type A CWC Interior Box
2	Type B - CWC Interior Box	RSC	CF	Domestic	SW	200	PPP-B-636	12	12	24	
2	Type B - CWC Exterior Box	RSC	DACFI			275	PPP-B-1163	12-1/2	12-1/2	24-1/2	Must be capable of containing Type B CWC Interior Box

Table 3-2

Specification of PVK, KFK and CWC Packaging Used in Blast Tests

Qty.	Application	Style	Type	Class	Variety	Grade	Conforming to Spec.	Inside Dimensions (in.)			Note
								Length	Width	Depth	
1	PVK Duct Box	FPF	CF	Domestic	SW	125	PPP-B-635	48-1/2	4-3/8	4-3/8	
1	PVK Interior Box	FOL	CF	Domestic	SW	200	PPP-B-636	59-1/4	17-1/4	37-1/4	
1	PVK Exterior Box	OSC	CF	Domestic	SW	275	PPP-B-636	59-3/4	17-3/4	37-3/4	Exterior should be wax coated; must be capable of containing PVK Interior Box...
1	Doorway Support Bar Box	FPF	CF	Domestic	SW	125	PPP-B-636	30-1/4	4-3/4	2	
1	Kearny Pump Interior Box	FOL	CF	Domestic	SW	125	PPP-B-636	30-3/4	5	41	
2	KFK Box A	OSC	CF	Domestic	SW	275	PPP-B-636	31-3/4	5-1/2	42	Exterior should be wax coated; must be capable of containing KP Interior Box.
2	A-Frame Interior Box	FOL	CF	Domestic	SW	125	PPP-B-636	5	5	95	
2	KFK Box B	OSC	CF	Domestic	SW	200	PPP-B-636	5-1/2	5-1/2	96	Exterior should be wax coated; must be capable of containing KP Interior Box.
4	Type A - CWC Interior Box	RSC	CF	Domestic	SW	200	PPP-B-636	24	20	6-1/4	
4	Type A - CWC Exterior Box	OSC	CF	Domestic	DM	275	PPP-B-636	24-1/2	6-3/4	20-1/2	Exterior should be wax coated; must be capable of containing Type A CWC Interior Box.
2	Type B - CWC Interior Box	RSC	CF	Domestic	SW	200	PPP-B-636	12	12	24	
2	Type B - CWC Exterior Box	RSC	CF	Domestic	DM	275	PPP-B-636	12-1/2	12-1/2	24-1/2	Exterior should be wax coated; must be capable of containing Type B CWC Interior Box.

Table 3-3
Size and Weight of Shelter Survival Supplies

Item	Packaged or Deployed	Dimension Per Unit						Floor Space Utilized	Weight lb	Quantity Needed for Test
		Diameter	Length	Width	Depth	Volume				
PVK	Packaged		59-3/4"	17-3/4"	37-3/4"	23.2 ft ³		96	1 Kit	
	Deployed		58"	16"	42"	22.6 ft ³	6.4 ft ²			
KPK	Box A		31-3/4"	5-1/2"	42"	4.2 ft ³		24		
		Box B		5-1/2"	96"	1.7 ft ³		28	1 Kit	
	Deployed A-Frame KP		105"	36"	80"	175.0 ft ³	26.3 ft ²			
CWC, Type A (Inflatable- wall)	Packaged		24-1/2"	6-3/4"	20-1/2"	2.0 ft ³		38	1 Kit	
CWC, Type B (Steel-wall)	Packaged		12-1/2"	12-1/2"	24-1/2"	2.2 ft ³		38		
	Deployed	72"			24"	56.5 ft ³	28.3 ft ²	2940 (filled)	1 Kit	
DPC			16"	16"	17-3/4"	2.6 ft ³		130 (filled)	4	
OCD Water Container		15-3/4"			22"	2.5 ft ³		156 (filled)	4	
Sanitation Kit, SK IV		16-1/2"			21-3/4"	2.7 ft ³		22	2 Kits	
Survival Biscuit Container	Packaged		19-1/4"	9-3/4"	14-1/2"	1.6 ft ³		38	6	
Radiation Kit	Packaged		16-1/4"	10-1/2"	10-3/4"	1.1 ft ³		15	2 Kits	

loading (forces due to the transient winds accompanying the passage of a blast wave), rather than to diffraction loading (forces due to the pressure differential in the early stages of target engulfment).

The peak pressures recorded at the various gages for each of the four tests are given in Tables 3-4, 3-5, 3-6, and 3-7 respectively, and the corresponding pressure traces in Appendix A. The individual test results are described below. It should be noted that the particular sequence of tests performed were designed to subject the equipment to an increasingly severe loading so as to obtain the maximum amount of information prior to destruction. Also, an approximately 5 psi overpressure at a basement shelter entrance represents in actuality a much higher overpressure, perhaps more than twice as high, at the ground level. This higher overpressure should be considered when estimating weapon size causing the damage found in the tests for items placed in basement shelters.

3.3.1 Test 1

In Test 1 the simulated shelter was in a dead-end configuration with the DPC's, OCD water containers, survival biscuit containers and the sanitation kits behind the front wall and the PVK, KPK, CWC's and radiation kits against the back wall (Figs. 3-4 and 3-5). The peak incident overpressures (at Gage C) was 5.2 psi and the positive phase duration (t^+) 131 msec. The peak reflected overpressure inside the test area, at the middle of the back wall (Gage X), was 8.6 psi and occurred 69 msec after the arrival of the blast wave at Gage C.

The peak incident pressures were calculated using the Rankine-Hugoniot equations from the recorded peak reflected pressures as follows (Ref. 5, p 122):

Table 3-4

Blast Test 1 - Peak Overpressures and Pressure Durations
(Refer to Fig. 3-2, page 3-5)

Gage	Test Identification	t_1^* msec	Peak Pressure, psig		t_p^* msec	t^+^* msec	t^-^* msec	Remarks
			Recorded	Incident (Calculated)**				
7	06077101	-1.4	11.6		3.1	137	55	Second peak occurs at $t = 48$ msec
C	06077101	0	12.0	5.2	1.6	131	59	Second peak occurs at $t = 52$ msec
F	06077101	3.7	7.8		60.0	141	53	
G	06077101	1.1	8.6		57.0	138	74	Brief negative phase before peak; ignored during calculation of t^+
H	06077101	1.5	7.8		54.7	139	52	Brief negative phase before peak; ignored during calculation of t^+
9	06077101	1.7	8.9		78.0	140	69	Brief negative phase before peak; ignored during calculation of t^+
10	06077101	6.0	8.4		64.3	127	79	
W	06077101	14.0	8.8	4.0	69.1	119	75	
X	06077101	13.3	8.6	3.9	68.8	118	86	Same data points after peak seem unreliable
Y	06077101	13.2	9.5	4.2	69.1	125	64	

- * t_1 , time of arrival of blast wave, relative to arrival of blast wave at Gage C
 t_p , time to reach peak overpressure, relative to arrival of blast wave at Gage C
 t^+ , positive phase duration
 t^- , negative phase duration

** Peak incident pressure calculated from peak reflected pressure
(in the case of normal incidence) using Table 3-8, page 3-19

Table 3-5

Blast Test 2 - Peak Overpressures and Pressure Durations
(Refer to Fig. 3-2, page 3-5)

Gage	Test Identification	t_1^* msec	Peak Pressure, psig		t_p^* msec	t^+^{**} msec	t^-^{**} msec	Remarks
			Recorded	Incident ** (Calculated)				
7	06087101	-1.5	10.2		45.1	114	74	
C	06097101	0	11.2	4.9	1.4	107	102	
F	06087101	2.2	5.6		33.1	107	56	Brief negative phase before peak; ignored during calculation of t^+
G	06087101	1.4	4.7		32.7	107	104	Brief negative phase before peak; ignored during calculation of t^+
H	06087101	0.9	5.1		31.7	109	100	Brief negative phase before peak; ignored during calculation of t^+
9	06087101	1.4	7.0		30.3	107	78	
10	06087101	5.6	5.7		52.1	106	96	Two (2) smaller peaks occur before indicated one
W	06087101	13.2	5.9	2.7	42.5	100	99	
X	06087101	14.0	5.6	2.6	14.6	92	109	
Y	06087101	14.1	7.1	3.3	19.2	99	52	

* t_1 , time of arrival of blast wave, relative to arrival of blast wave at Gage C

t_p , time to reach peak overpressure, relative to arrival of blast wave at Gage C

t^+ , positive phase duration

t^- , negative phase duration

** Peak incident pressure calculated from peak reflected pressure (in the case of normal incidence) using Table 3-8, page 3-19

Table 3-6

Blast Test 3 - Peak Overpressures and Pressure Durations

(Refer to Fig. 3-2, page 3-5)

Gage	Test Identification	t_1^* msec	Peak Pressure ps.		t_p^* msec	t^+^* msec	t^-^* msec	Remarks
			Recorded	Incident ** (calculated)				
7	06097101	-1.7	11.1		11.5	148	38	
C	06097101	0	11.4	5.0	36.4	136	53	Smaller peak occurs at $t = 1.6$ msec
F	06097101	1.7	8.2		54.3	138	52	Brief negative phase before peak; ignored during calculation of t^+
G	06097101	1.3	8.9		55.8	141	65	Brief negative phase before peak; ignored during calculation of t^+
H	06097101	1.2	8.6		58.6	141	58	Brief negative phase before peak; ignored during calculation of t^+
9	06097101	1.6	8.8		68.8	144	54	
10	06097101	5.6	8.2		51.6	134	89	
W	06097101	13.3	9.4	4.2	68.8	118	81	Second peak occurs at $t = 41.9$ msec
X	06097101	14.0	8.8	4.0	67.0	123	69	
Y	06097101	14.1	--		66.7	122	68	Doubtful results at $65 < t < 67$ msec

* t_1 , time of arrival of blast wave, relative to arrival of blast wave at Gage C t_p , time to reach peak overpressure, relative to arrival of blast wave at Gage C t^+ , positive phase duration t^- , negative phase duration

** Peak incident pressure calculated from peak reflected pressure (in the case of normal incidence) using Table 3-8, page 3-19

Table 3-7

Blast Test 4 - Peak Overpressures and Pressure Durations

(Refer to Fig. 3-2, page 3-5)

Gage	Test Identification	t_1^* msec	Peak Pressure, psig		t_p^* msec	t^+^{**} msec	t^-^{**} msec	Remarks
			Recorded	Incident ** (Calculated)				
7	06097102	-1.6	11.5		47.1	125	61	
C	06097102	0	12.3	5.4	45.3	111	71	
F	06097102	2.2	5.9		38.0	114	73	Brief negative phase occurs before peak; ignored in calculation of t^-
G	06097102	1.0	5.8		55.2	112	100	Brief negative phase occurs before peak; ignored in calculation of t^-
H	06097102	1.0	6.1		26.4	112	40	Brief negative phase occurs before peak; ignored in calculation of t^-
9	06097102	1.6	6.2		30.1	111	72	
10	06097102	5.7	6.4		52.1	107	98	
W	06097102	13.3	6.8	3.1	58.3	102	95	
X	06097102	13.8	6.3	2.9	14.0	--	--	Recorded data ends at $t = 76.1$ msec
Y	06097102	14.3	6.7	3.1	14.4	96	103	

* t_1 , time of arrival of blast wave, relative to arrival of blast wave at Gage C t_p , time to reach peak overpressure, relative to arrival of blast wave at Gage C t^+ , positive phase duration, t^- , negative phase duration

** Peak incident pressure calculated from peak reflected pressure (in the case of normal incidence) using Table 3-8, page 3-19

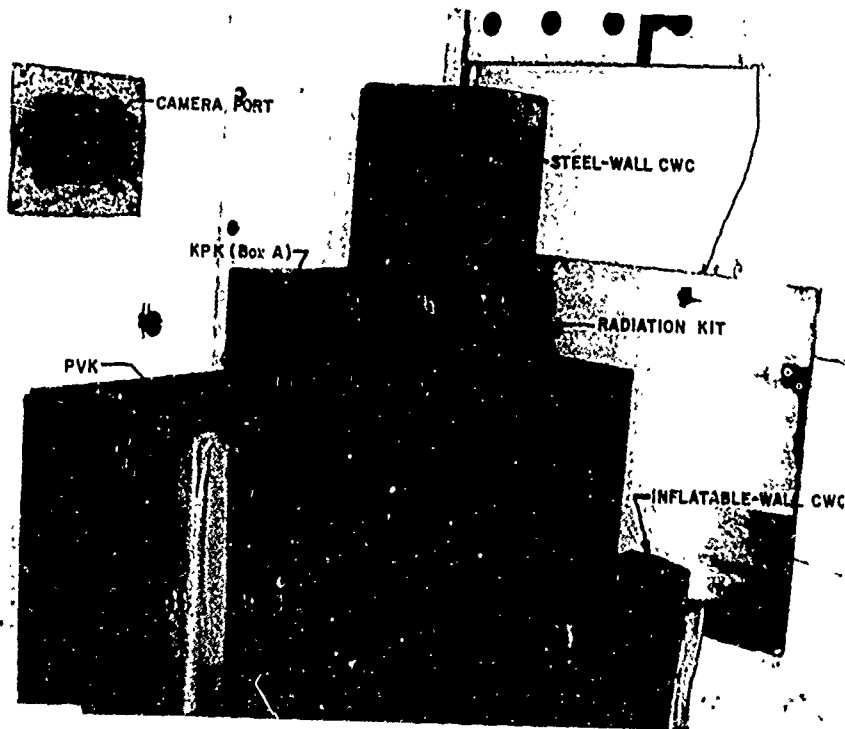
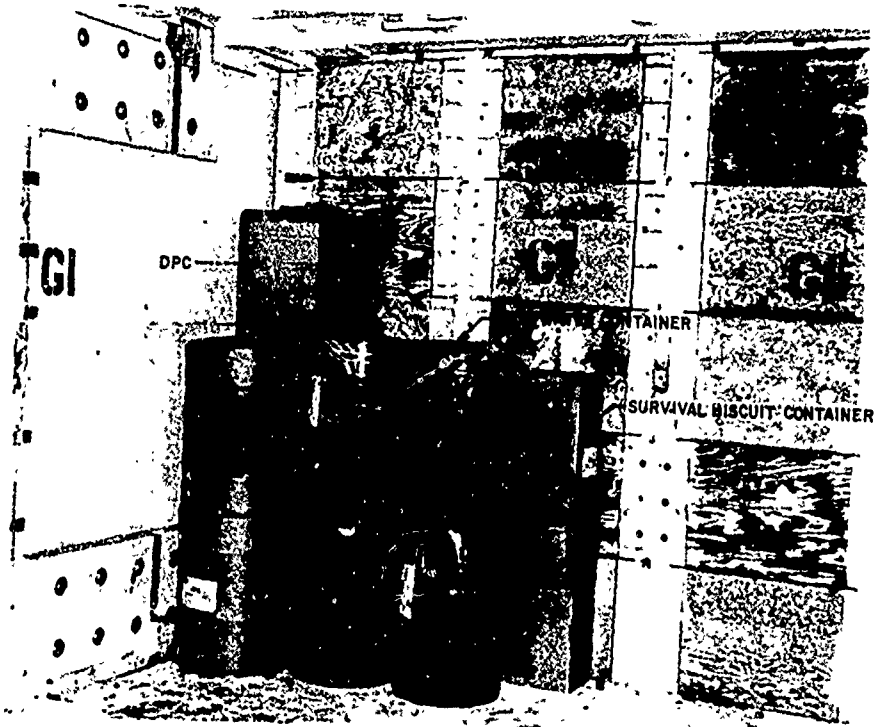
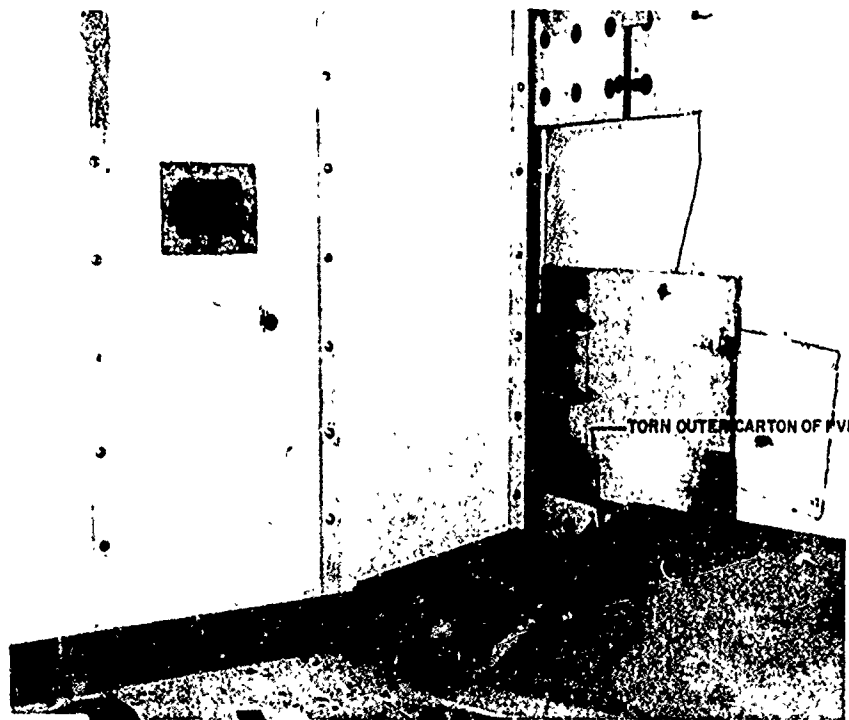

Figure 3-4 Test 1 - Before Blast



WATER RETAINED BY LINER



TORN OUTER CARTON OF PVK

Figure 3-5 Test 1 - After 5.2 psi Peak Incident Overpressure Blast

$$\begin{aligned}
 p_r &= 2p + (\gamma + 1)q \\
 &= 2p \left(\frac{7P_o + 4p}{7P_o + p} \right)
 \end{aligned}$$

Where p_r = instantaneous peak reflected overpressure, psi

p = peak overpressure (behind the shock front), psi

γ = ratio of the specific heats

≈ 1.4 (for air)

P_o = ambient pressure (ahead of the shock front), psi

Calculated values of p_r vs. p are given in Table 3-8 for ready reference.

The results of the tests, briefly, are the following:

- 1) The DPC's were unaffected.
- 2) Two of the OCD water containers were toppled and squashed. The water however, was not spilled; it was retained by the liner.
- 3) Two of the survival biscuit containers were toppled but were undamaged.
- 4) One of the sanitary containers was toppled but was undamaged.
- 5) The PVK box was toppled and the outer carton ripped open, but the PVK was undamaged.
- 6) The KPK, CWC's and radiation kits were all displaced from their storage positions by the blast wave but were undamaged.

3.3.2 Test 2

In Test 2 the simulated shelter was in a flow-through configuration with the same supplies as in Test 1. The position of the supplies behind the front wall was placed as shown in Fig. 3-2.

The peak incident overpressure (at Gage C) was 4.9 psi, and the positive phase duration 107 msec. The peak reflected overpressure inside the test area in the middle of the back wall (Gage X) was 5.6 psi and was reached

Table 3-8

(a)				(b)			
Gauge Measured Reflected Pressure (P(R)) Due to Incident Overpressure (P(I))				Incident Overpressure (P(I)) Due to Gauge Measured Reflected Pressure (P(R))			
P(I)	P(R)	P(I)	P(R)	P(I)	P(R)	P(I)	P(R)
0.10	0.20	5.10	11.64	15.10	41.79	0.10	0.04
0.20	0.40	5.30	11.90	15.20	42.13	0.20	0.09
0.30	0.60	5.40	12.15	15.30	42.48	0.30	0.14
0.40	0.80	5.40	12.41	15.40	42.82	0.40	0.19
0.50	1.01	5.50	12.67	15.50	43.17	0.50	0.24
0.60	1.22	5.60	12.93	15.60	43.52	0.60	0.29
0.70	1.42	5.70	13.19	15.70	43.86	0.70	0.34
0.80	1.63	5.80	13.45	15.80	44.21	0.80	0.39
0.90	1.84	5.90	13.71	15.90	44.56	0.90	0.44
1.00	2.05	6.00	13.98	16.00	44.91	1.00	0.49
1.10	2.26	6.10	14.24	16.10	45.26	1.10	0.54
1.20	2.48	6.20	14.51	16.20	45.62	1.20	0.58
1.30	2.69	6.30	14.78	16.30	45.97	1.30	0.63
1.40	2.91	6.40	15.04	16.40	46.32	1.40	0.68
1.50	3.12	6.50	15.31	16.50	46.68	1.50	0.73
1.60	3.34	6.60	15.58	16.60	47.03	1.60	0.78
1.70	3.56	6.70	15.85	16.70	47.39	1.70	0.83
1.80	3.78	6.80	16.12	16.80	47.74	1.80	0.87
1.90	4.00	6.90	16.40	16.90	48.10	1.90	0.92
2.00	4.22	7.00	16.67	17.00	48.46	2.00	0.97
2.10	4.45	7.10	16.94	17.10	48.82	2.10	1.01
2.20	4.67	7.20	17.22	17.20	49.17	2.20	1.06
2.30	4.90	7.30	17.50	17.30	49.53	2.30	1.11
2.40	5.12	7.40	17.77	17.40	49.90	2.40	1.16
2.50	5.35	7.50	18.05	17.50	50.26	2.50	1.20
2.60	5.58	7.60	18.33	17.60	50.62	2.60	1.25
2.70	5.81	7.70	18.61	17.70	50.98	2.70	1.30
2.80	6.04	7.80	18.89	17.80	51.35	2.80	1.34
2.90	6.27	7.90	19.17	17.90	51.71	2.90	1.39
3.00	6.50	8.00	19.46	18.00	52.07	3.00	1.44
3.10	6.74	8.10	19.74	18.10	52.44	3.10	1.48
3.20	6.97	8.20	20.03	18.20	52.81	3.20	1.53
3.30	7.21	8.30	20.31	18.30	53.17	3.30	1.57
3.40	7.45	8.40	20.60	18.40	53.54	3.40	1.62
3.50	7.69	8.50	20.89	18.50	53.91	3.50	1.66
3.60	7.93	8.60	21.17	18.60	54.28	3.60	1.71
3.70	8.17	8.70	21.46	18.70	54.65	3.70	1.76
3.80	8.41	8.80	21.75	18.80	55.02	3.80	1.80
3.90	8.65	8.90	22.05	18.90	55.39	3.90	1.85
4.00	8.89	9.00	22.34	19.00	55.76	4.00	1.89
4.10	9.14	9.10	22.63	19.10	56.14	4.10	1.94
4.20	9.38	9.20	22.93	19.20	56.51	4.20	1.98
4.30	9.63	9.30	23.22	19.30	56.88	4.30	2.03
4.40	9.88	9.40	23.52	19.40	57.26	4.40	2.07
4.50	10.13	9.50	23.81	19.50	57.63	4.50	2.12
4.60	10.38	9.60	24.11	19.60	58.01	4.60	2.16
4.70	10.63	9.70	24.41	19.70	58.39	4.70	2.21
4.80	10.88	9.80	24.71	19.80	58.77	4.80	2.25
4.90	11.13	9.90	25.01	19.90	59.14	4.90	2.29
5.00	11.39	10.00	25.31	20.00	59.52	5.00	2.34

43 msec after the arrival of the blast wave at Gage C. The initial jet velocity through the test area was approximately 1214 ft/sec (828 miles/hr).

The results of the tests are the following (Fig. 3-6):

- 1) The DPC's were unaffected
- 2) The OCD water containers were unaffected
- 3) The survival biscuit containers were unaffected
- 4) The PVK outer and inner cartons were torn open but the contents were not damaged.
- 5) One of the sanitary containers was toppled but the contents were not damaged.
- 6) The KPK A-frame and flap-section boxes were both perforated by bolts protruding from the back wall. The contents were not damaged.
- 7) The CWC's were not damaged.
- 8) The radiation kits were toppled but were apparently not damaged.

3.3.3 Test 3

In Test 3 the simulated shelter was again in a dead-end configuration with only the deployed PV, A-frame KP and the steel-wall CWC. The CWC was filled to capacity with approximately 350-gallons of water.

The peak incident overpressure (at Gage C) was 5.0 psi and the positive phase duration 136 msec. The peak reflected overpressure in the test area at the middle of the back wall (Gage X) was 8.8 psi and occurred 67 msec after the arrival of the blast wave at Gage C.

The results of the tests are the following (Figs. 3-7, 3-8):

- 1) The deployed PV was displaced several inches from its original position but was undamaged.
- 2) The deployed KP was almost completely destroyed; parts of it were found lying in the deployed CWC. The legs of the A-frame were

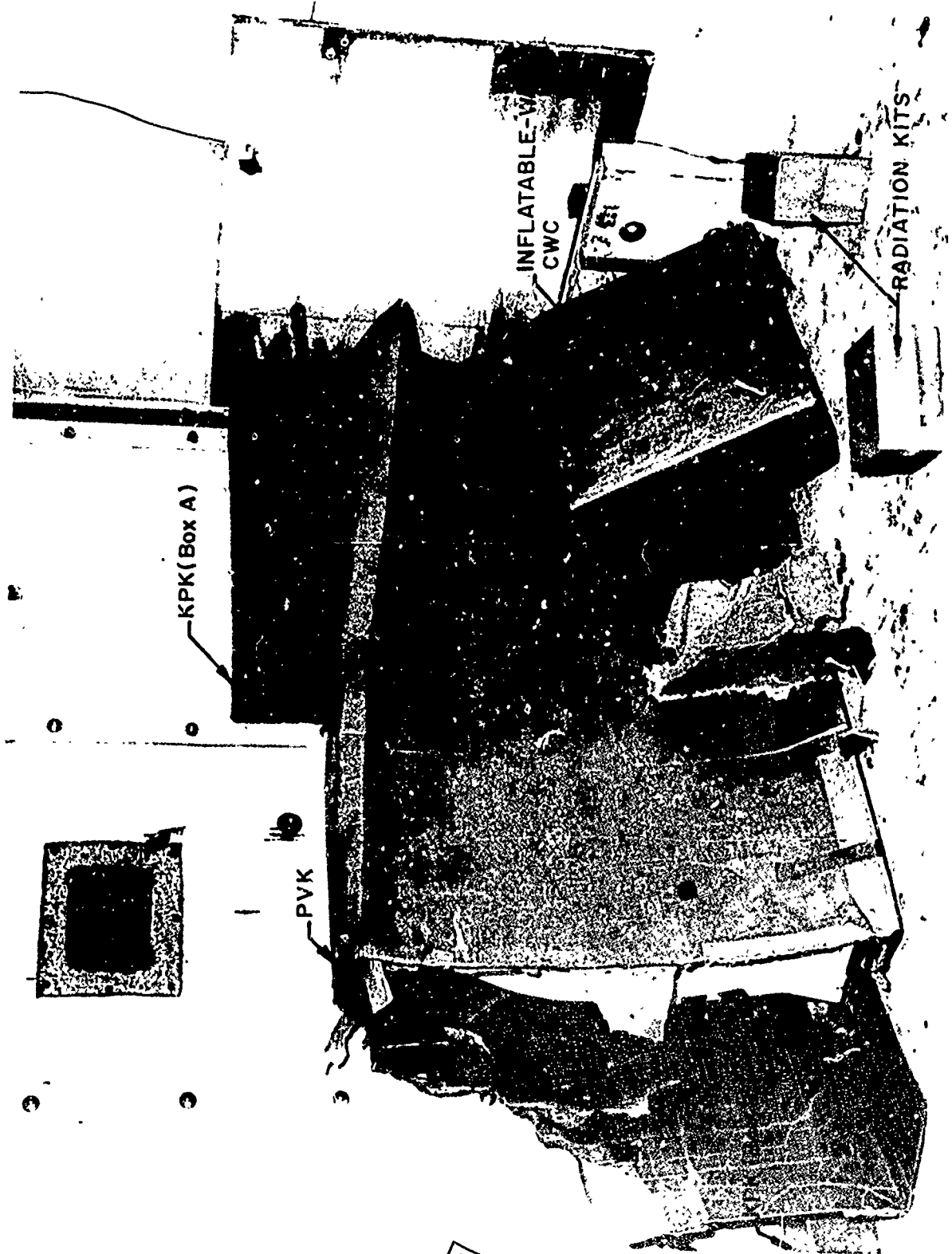

Figure 3-6 Test 2 - After 4.9 psi Peak Incident Overpressure Blast

Reproduced from
best available copy.

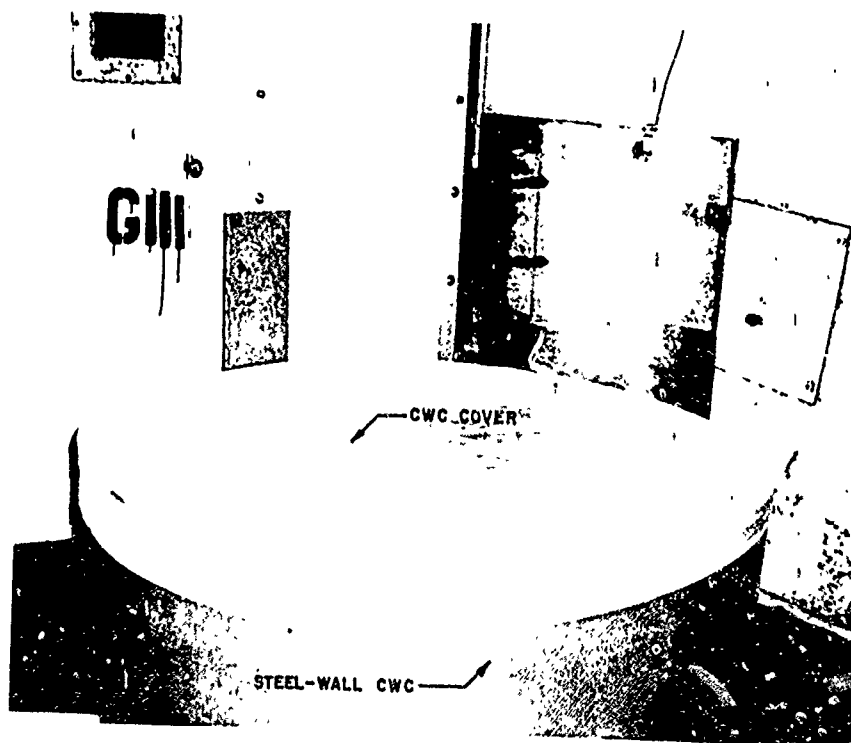
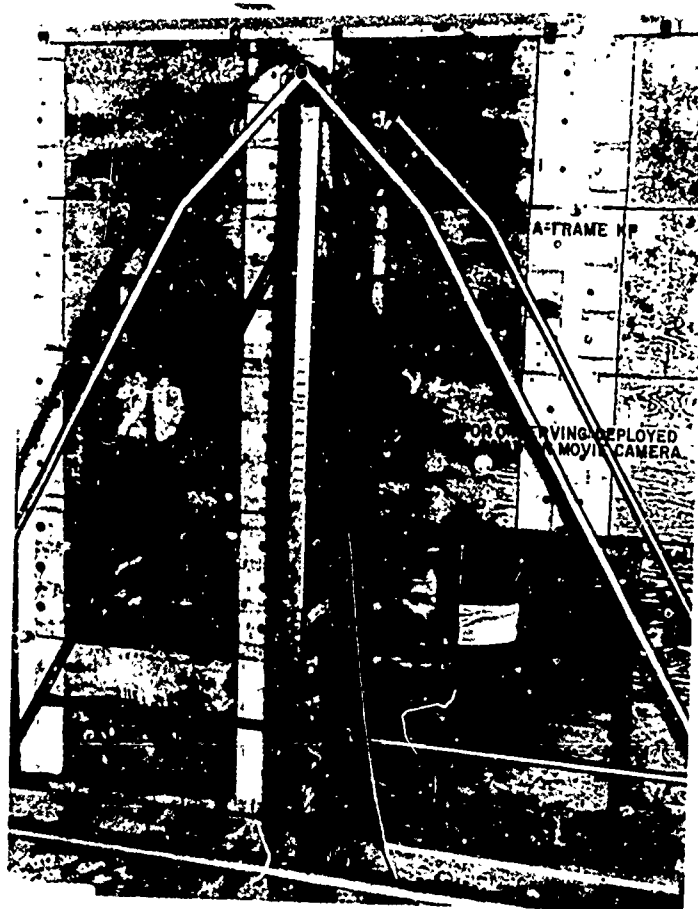
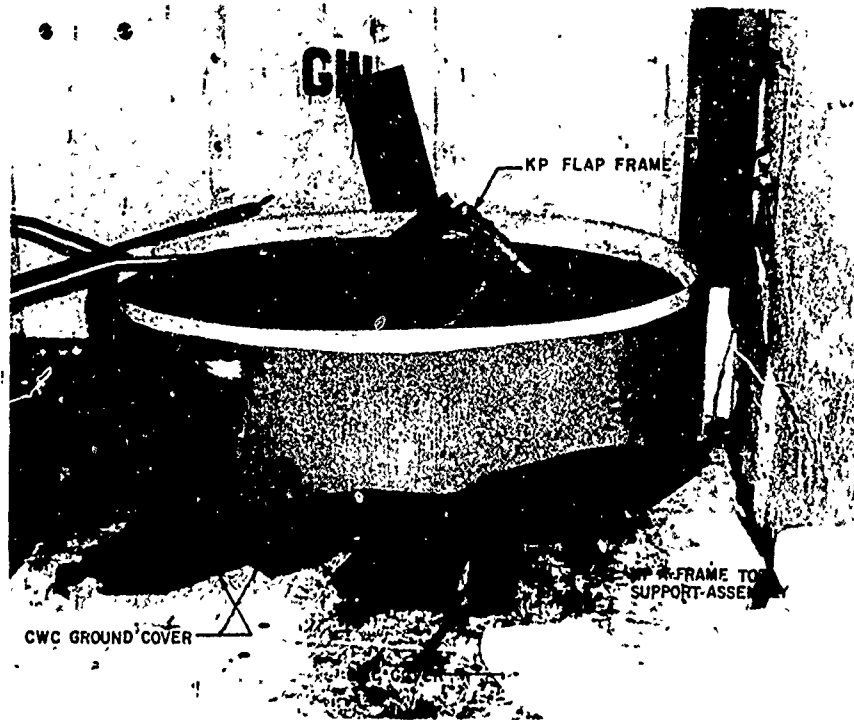

Figure 3-7 Test 3 - Before Blast



Reproduced from
best available copy.

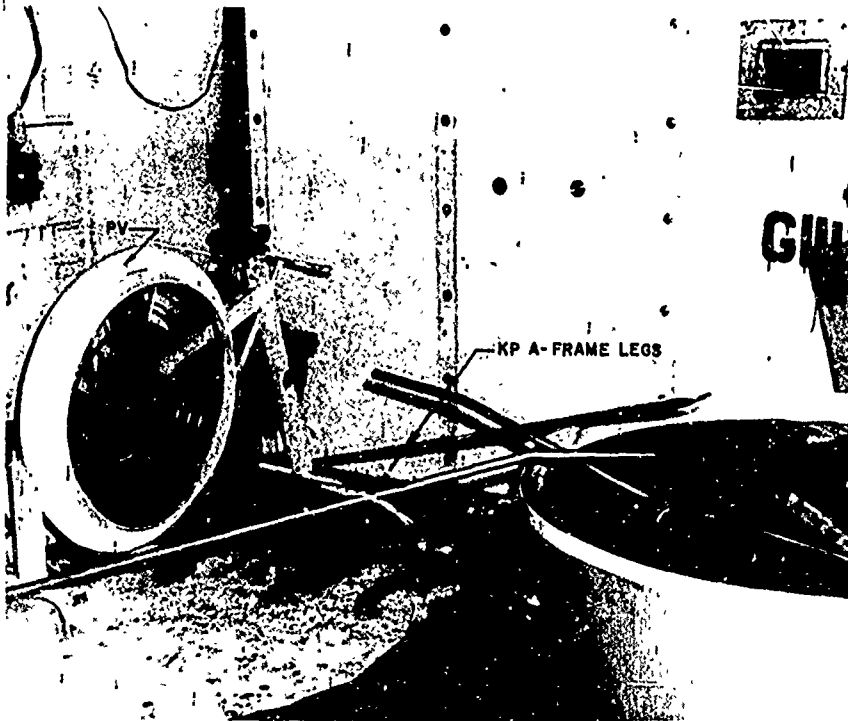

Figure 3-8 Test 3 - After 5.0 psi Peak Incident Overpressure Blast

separated, one of the flap frames was broken and one of the frame tie-plates was fractured. All the plastic flaps and hinge wires were blown off the frame. Some of the hinge wires were found imbedded in the concrete roof and walls and required a fair amount of force to remove. Because of the fractured flap frame and tie-plate, it was judged that it would be impossible for the shelterees to reassemble and use the KP with the simple tools which will probably be available in the shelter.

- 3) The protective cover of the CWC was blown off and approximately 35 gallons (10%) of the water spilled. The CWC was otherwise intact.

3.3.4 Test 4

In Test 4 the simulated shelter was identical to that in Test 2, a flow-through configuration (Fig. 3-3). The only item evaluated in this test was the deployed PV.

The peak incident overpressure (at Gage C) was 5.4 psi and the positive phase duration was 111 msec. The peak reflected overpressure inside the test area at the middle of the back wall (at Gage X) was 6.3 psi and was reached 14 msec after the arrival of the blast wave at Gage C. The initial jet velocity through the test area was 1278 ft/sec (871 miles/hr).

After the test it was observed that the PV had moved a few inches from its original position. The blades were not bent although they faced the blast directly. The chain was not displaced off the sprockets. The PV was found to be in perfect operable condition.

3.4 Conclusions and Recommendations

Based on the results of the four tests described above, the following is concluded and recommended:

- 1) The Kearny pump as designed is not expected to survive peak incident overpressures as high as 5 psi. It was almost completely destroyed when tested in the deployed state at this overpressure. In addition, translation of debris from the damaged KP might cause serious injuries to the shelterees; a few of the flap hinge wires were found imbedded in the concrete walls and ceilings of the test shelter after the test and required a fair amount of force to remove. However, the packaged KP was unaffected by the blast.

Based on the above it is recommended that alternate methods of hinging the flaps to the frame (as, for example, by using nylon cord rather than metal wire), and more positive methods of assembling the components of the A-frame, be investigated. In addition, double stocking of the KPK should be considered so that a second KP is available if the first is destroyed by blast. No change in the packaging of the KP is recommended.

- 2) The pedal ventilator as designed and set up in "protected" locations is satisfactory at blast overpressures of 5 psi. The packaging although torn in the tests is considered adequate for the application. No change in the PV design or packaging is recommended. (This result is different from that reported previously for the PV in References 8, 9, and 16, in which PV's were extensively damaged by 4 psi blasts. The difference stems from the fact that in those tests the PV's were allowed to translate and thus were not in protected locations - against the wall - as in the present test.)

- 3) Filled and stacked cubical plastic dual-purpose water containers were found to be very stable. In no test were they moved from their original position as a result of the blast, and as a consequence none of the stored water was lost.
The DPC's are recommended for shelter use.
- 4) The OCD water container was toppled in one test, but the water was retained by the liner. The liner however was brand new, but had it been in use for some time, and presumably deteriorated, it very likely would not have been able to retain the water.
- 5) The steel-wall collapsible water container (350-gallon capacity) has adequate strength to withstand 5 psi overpressure blast wave when deployed. About 10% of the water was lost because the container protective cover was blown off just prior to a transient deformation of the CWC by the blast wave. To reduce this loss, it is recommended that positive methods for anchoring the cover to the container be investigated.
- 6) The other OCD-provided supplies (radiation kits, survival biscuits containers and sanitation kits) were undamaged by the 5 psi blast wave and appear to be adequately packaged.
- 7) Definitive recommendations from these tests regarding the preferred storage locations of supplies within shelters to provide maximum protection from blast overpressures, in general cannot be made because the tests were conducted in a shelter of relatively simple geometry. Actual shelters can have complex geometries and the recorded test data probably cannot be reliably or readily extrapolated to cover them. However, the following guidelines are suggested:

- a) Drag-sensitive items should be placed away from the likely path of a blast wave.
- b) Packaged items should be stored against walls in areas where they will be subjected to compression only rather than translation. The walls in these areas should be smooth (no protuberances) to prevent possible damage to supplies.
- c) Impact-sensitive items, such as radiation kits, should be stored near the floor to prevent damage due to dropping.

SECTION 4

APPLICABILITY OF LARGE FAN VENTILATORS TO SHELTERS

The performance characteristics of large fan ventilators, i.e., the curves of static pressure vs. flow rate, were determined for ventilators with 52" and 60" diameter fans under a previous OCD contract (Fig. 4-1, and Ref. 8). This study was undertaken to locate devices which would economically move large volumes of air without ducts at low pressure heads, for possible use as ventilators in large shelters.

Comparison of the performance curves of these devices with that for the pedal ventilator, for the same input horsepower, shows that while the large fan ventilators (LFV's) develop smaller zero-flow static pressures than the PV, they have much larger free-air deliveries (Fig. 4-2). Thus it would appear that the LFV's could produce more ventilation than the PV's in shelters which have physical characteristics that result in very small pressure drops, and hence the LFV's could be desirable ventilating devices. The purpose of the present study was to investigate this possibility by determining the percentage of the NFSS (National Fallout Shelter Survey) basement shelters in which the LFV's could be advantageously employed. An additional task was to determine if the substitution of the PV's by the LFV's could be economically justified.

4.1 Study Approach

The study was based on a ventilability analysis of a sample of 239 basement shelters (GARD Sample) selected to represent the NFSS shelters, both in geometrical characteristics and shelter ventilation requirements.

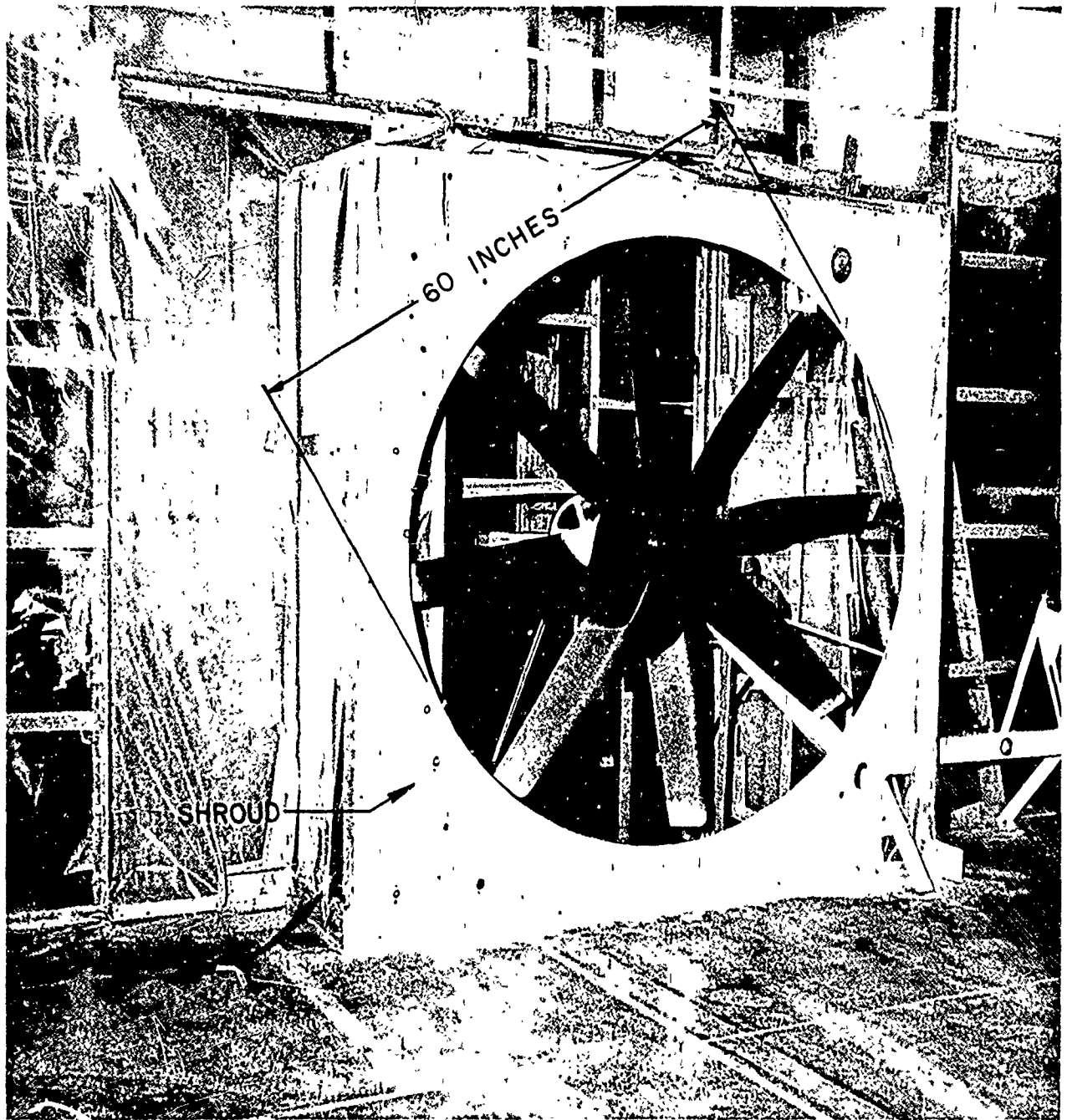

Reproduced from
best available copy. 

Figure 4-1 Large Fan Ventilator with Shroud, Inside Room

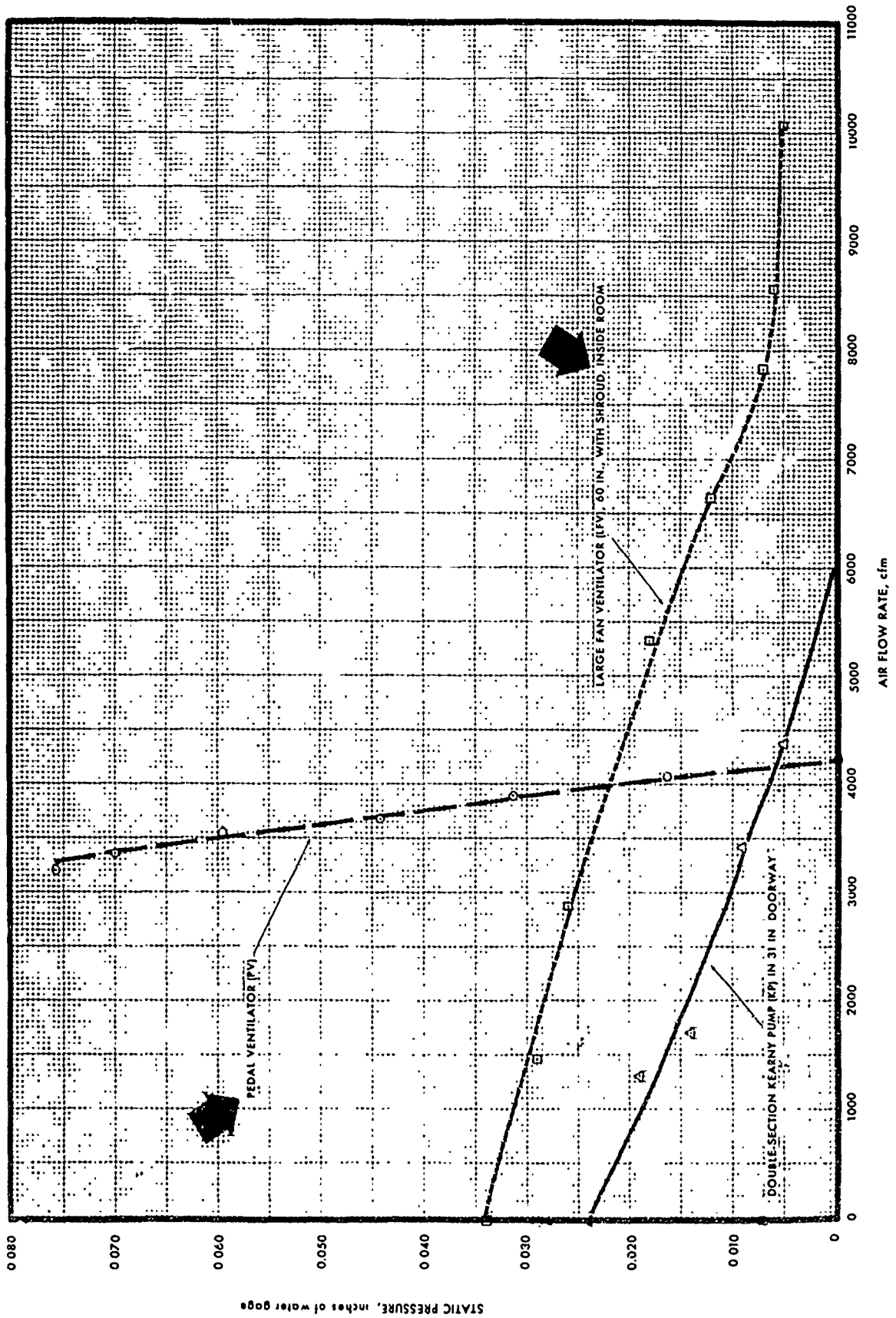

Figure 4-2 Ventilator Performance Curves for 0.1 Horsepower Input

The GARD sample of shelters (Appendix B) was assembled under a previous OCD contract and was derived from a Research Triangle Institute (RTI) survey (Ref. 7), and a Corp of Engineers survey (Ref. 12 and Fig. 4-3). The RTI sample was formed to reflect the regional shelter distribution in the country. OCD has accepted this survey as being representative of the nationwide fallout shelters on a geometrical basis; conclusions regarding shelter geometry obtained from the sample have been assumed to apply on a country-wide basis. The RTI sample however does not closely relate to the national distribution of shelters on a ventilation requirement basis; it was developed before ventilation requirement information was available. To compensate for this, 164 shelter samples were selected from the Corp of Engineers survey (Ref. 4) and combined with 75 samples from the RTI survey to give the composite GARD sample (all basement shelters) which are representative of NFSS shelters. An important aspect of the GARD sample is that floor plans for each shelter is available. Further information regarding the GARD sample, together with details of the checks performed to ensure that it closely represents NFSS shelters is given in Reference 12.

The ventilability analysis with the PV was performed in the following manner. A shelter floor plan was analyzed to determine the optimum placement of one PV to ventilate the shelter. For this PV location, the length of the required duct, type and number of bends in the duct, and the inlet aperture area were determined. The flow produced by the PV was then computed from this information by the procedure given in Section 4.2. The computations were then repeated for multiple PV's in the shelters. All shelters were similarly treated.

The ventilability analysis with the LFV was computed only for the 60"

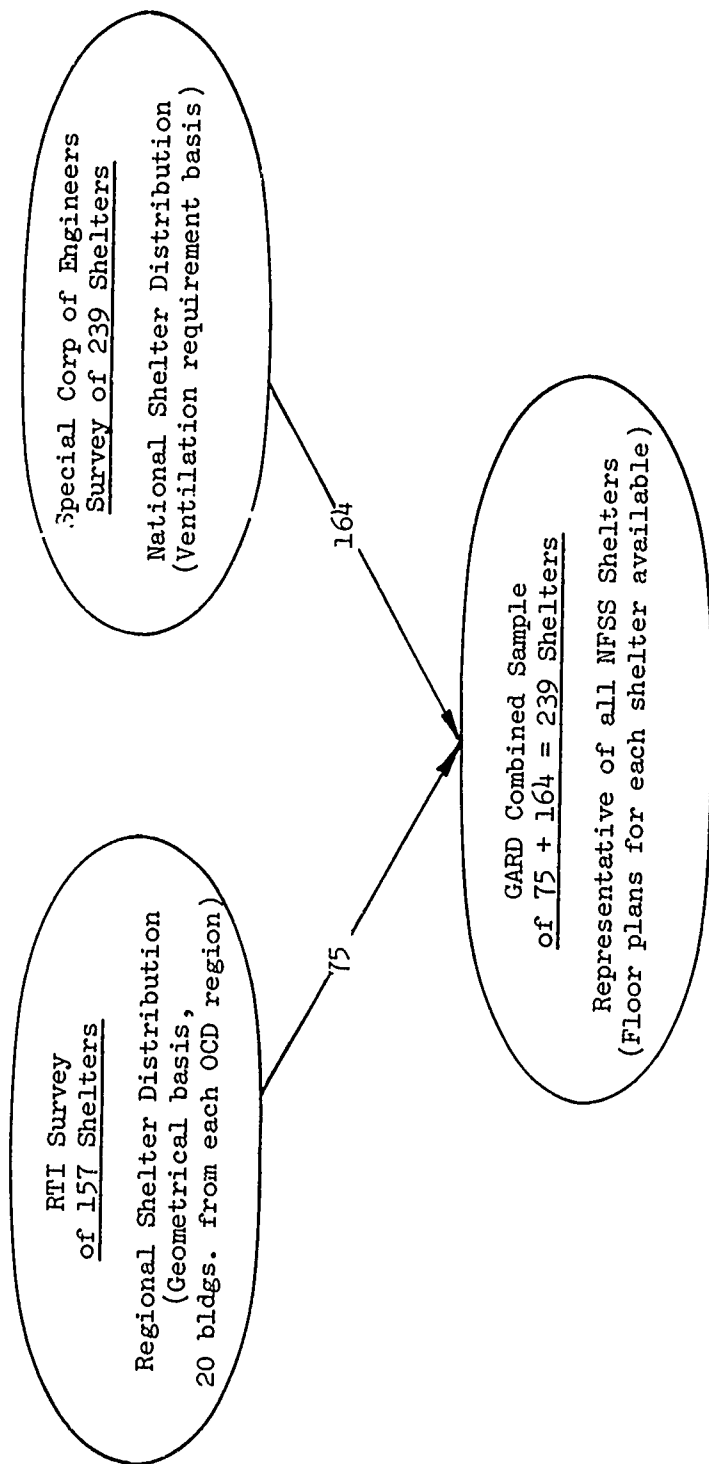

Figure 4-3 GARD Sample of Basement Shelters

diameter fan with shroud in a manner somewhat similar to that for the PV. The exceptions were that shelters that did not have either an external doorway or an elevator shaft as possible sources of fresh air inlet were considered unventilable. These large air sources are necessary if an LFV is to be used, since the LFV's will be deployed at these locations. In addition, shelters in which the use of ducts was mandatory for adequate ventilation were rejected, since ducts would not be furnished with LFV's.

4.2 Shelter Air Flow Rate Computation for the Pedal Ventilator

The air flow produced in a shelter by a PV is determined by the following:

- 1) Power input to the fan
- 2) Pressure losses in the ducting attached to the fan
- 3) The pressure losses across the inlet apertures, and
- 4) The pressure losses due to air flow in interior openings.

(This particular loss is small in comparison to the others and was ignored in keeping with the common building air-conditioning system design practice.)

For the PV with 0.1 hp input (the design power input) the following holds:*

$$P_p = 1.661 \times 10^{-9} Q^2 - 7.192 \times 10^{-5} Q + 2.709 \times 10^{-1}$$

where

P_p = static pressure produced by the PV, in. of water

Q = air flow rate, cfm

The pressure loss in the 30-inch diameter polyethylene duct used with the PV is given:

* Least square polynomial fit to experimental data.

$$P_d = e^{(\alpha\Lambda + \beta)Q_{-1}}$$

where

P_d = duct pressure loss, in. of water

Λ = effective duct length (EDL), ft

$$= L_a + \Sigma L_b$$

(L_a = physical length of duct, ft.)

L_b = length equivalent of duct constrictions, ft., Table 4-1)

$$\alpha = 6.498 \times 10^{-8}$$

$$\beta = 5.692 \times 10^{-6}$$

Table 4-1

Length Equivalent (L_b) for Constrictions of 30-Inch Polyethylene Duct

Constriction	L_b
90° pre-formed elbow (30" radius)	220 ft.
90° pre-formed elbow (45" radius)	160 ft.
90° bend	615 ft.
45° bend	470 ft.

The losses across inlet apertures are given by (Ref. 1, pp 31-33):

$$P_a = 6.234 \times 10^{-8} C \left(\frac{Q}{A}\right)^2$$

where

P_a = dynamic loss of total pressure, in. of water

C = dynamic loss coefficient (an experimentally determined constant)

≈ 2

A = aperture area, ft.²

Thus the net flow for one PV is given by the zeros of the following function, $\phi(q)$:

$$\phi(q) = 1.661 \times 10^{-5} q^2 - 7.192 \times 10^{-5} q + 2.709 \times 10^{-1} - e^{(\alpha\Lambda + \beta)q+1} - 6.234 \times 10^{-8} C \left(\frac{q}{A_t}\right)^2$$

where

A_t = total inlet aperture area, ft.²

The total flow for "n" PV's is then given by Q_n :

$$Q_n = nq$$

The above procedure for the flow calculation for the PV was computerized.

4.3 Shelter Air Flow Rate Computation for the Large Fan Ventilator

The air flow produced in a shelter by a LFV is determined by the following:

- 1) Power input to the LFV
- 2) Pressure losses across the inlet aperture, and
- 3) Pressure losses due to air flow in interior opening. (This was again ignored because of the reasons mentioned previously).

For the LFV consisting of the 60" diameter fan inside room with shroud, the following holds for 0.1 hp power input:*

For $0 \leq Q \leq 6500$:

$$P_{J,1} = -8.956 \times 10^{-11} Q^2 - 2.738 \times 10^{-6} Q + 3.426 \times 10^{-2}$$

where

P_{L1} = static pressure produced by the LFV, in. of water

For $6500 < Q \leq 10000$:

$$P_{L2} = -2.041 \times 10^{-13} Q^3 + 5.959 \times 10^{-9} Q^2 - 5.814 \times 10^{-5} Q + 1.949 \times 10^{-1}$$

* Least square polynomial fit to experimental data.

where

P_{L2} = static pressure produced by the LFV, in. of water

Thus the flow for one LFV is given by the zeros of either of the following two functions, $\Psi_1(q)$ or $\Psi_2(q)$, depending on the magnitude of the flow:

$$\Psi_1(q) = -8.956 \times 10^{-11} q^2 - 2.738 \times 10^{-6} q + 3.426 \times 10^{-2} - 6.234 \times 10^{-8} C \left(\frac{q}{A_t}\right)^2 \quad \left. \vphantom{\Psi_1(q)} \right\} 0 \leq q \leq 6500$$

or
$$\Psi_2(q) = -2.041 \times 10^{-13} q^3 + 5.959 \times 10^{-9} q^2 - 5.814 \times 10^{-5} q + 1.949 \times 10^{-1} - 6.234 \times 10^{-8} C \left(\frac{q}{A_t}\right)^2 \quad \left. \vphantom{\Psi_2(q)} \right\} 6500 < q \leq 10000$$

The total flow for "n" LFV's is then given by:

$$Q_n = nq$$

Here q is first computed using function $\Psi_1(q)$, and if greater than 6500 cfm, recomputed using function $\Psi_2(q)$. This procedure for the flow calculation for the LFV was also computerized.

4.4 Results, Conclusions and Recommendations

Each of the 239 shelters in the GARD shelter sample were analyzed to determine the air flow produced for multiple number of PV's and LFV's. If a particular shelter required more than 10 ventilators to fully ventilate, i.e., to provide the required ventilation based on its ventilation zone and rated maximum occupancy, it was considered unventilable. Based on this criteria Tables 4-2 and 4-3 giving the required PV's or LFV's for each shelter were generated. From these tables it can be seen that of the 239 shelters, 21 are unventilable, 218 ventilable by the PV and only 123 by the LFV.

The economic analysis to determine the feasibility of using LFV's from a cost standpoint was conducted by assuming a unit cost for the PVK (\$1.00) and a relative cost for the LFV which varied between \$1.00 and \$4.95 (Tables 4-4(a), 4-4(b)). Normalized costs were employed so as not to render conclusions

Table 4-2

GARD SHELTER SAMPLE

NUMBER OF PVK'S OR LFV'S REQUIRED TO FULLY VENTILATE SHELTERS

SHELTER	NUMBER OF PVK'S OR LFV'S REQUIRED TO FULLY VENTILATE SHELTERS		SHELTER SAMPLE		NUMBER OF PVK'S OR LFV'S REQUIRED TO FULLY VENTILATE SHELTERS		SHELTER SAMPLE		NUMBER OF PVK'S OR LFV'S REQUIRED TO FULLY VENTILATE SHELTERS		SHELTER SAMPLE	
	PVK	LFV	SHELTER	PVK LFV	SHELTER	PVK LFV	SHELTER	PVK LFV	SHELTER	PVK LFV	SHELTER	PVK LFV
1	4	3	2	0 0	3	0 0	4	3 0	5	2 0	5	2 0
6	2	1	7	1 0	8	3 1	9	1 1	10	1 1	10	1 1
11	1	1	12	1 1	13	3 0	14	1 1	15	1 1	15	1 1
16	6	2	17	3 1	18	1 0	19	2 1	20	1 1	20	1 1
21	5	2	22	4 2	23	2 1	24	1 0	25	3 2	25	3 2
26	1	1	27	1 0	28	3 1	29	4 0	30	2 0	30	2 0
31	2	1	32	3 1	33	3 1	34	2 1	35	3 1	35	3 1
36	1	0	37	1 0	38	0 0	39	2 1	40	9 0	40	9 0
41	7	0	42	3 1	43	4 2	44	6 0	45	3 1	45	3 1
46	4	0	47	1 0	48	3 1	49	1 1	50	3 0	50	3 0
51	2	1	52	1 0	53	1 0	54	2 1	55	0 0	55	0 0
56	2	1	57	1 0	58	5 0	59	3 0	60	3 0	60	3 0
61	2	0	62	3 4	63	0 0	64	6 2	65	2 1	65	2 1
66	2	1	67	1 1	68	0 0	69	3 1	70	3 1	70	3 1
71	3	0	72	2 1	73	3 1	74	0 0	75	4 0	75	4 0
76	0	0	77	0 0	78	3 1	79	3 1	80	0 0	80	0 0
81	3	1	82	2 1	83	3 0	84	1 1	85	2 0	85	2 0
86	2	1	87	2 0	88	3 0	89	3 1	90	3 0	90	3 0
91	3	0	92	1 0	93	2 0	94	2 1	95	1 0	95	1 0
96	0	0	97	2 0	98	0 0	99	5 2	100	6 5	100	6 5
101	2	1	102	2 0	103	4 2	104	0 0	105	2 0	105	2 0
106	4	0	107	3 1	108	1 0	109	1 0	110	2 1	110	2 1
111	2	1	112	0 0	113	3 0	114	1 1	115	2 1	115	2 1
116	3	0	117	3 1	118	2 0	119	3 0	120	1 0	120	1 0
121	2	0	122	2 1	123	2 0	124	2 1	125	1 1	125	1 1
126	4	1	127	3 1	128	3 0	129	5 0	130	2 0	130	2 0
131	2	1	132	2 1	133	2 1	134	2 1	135	1 0	135	1 0
136	2	0	137	1 0	138	2 1	139	2 1	140	1 0	140	1 0
141	7	3	142	1 1	143	4 0	144	4 2	145	3 0	145	3 0
146	0	0	147	10 4	148	7 0	149	3 1	150	2 1	150	2 1
151	4	0	152	2 0	153	4 0	154	4 0	155	2 0	155	2 0
156	2	0	157	2 0	158	1 0	159	3 2	160	2 1	160	2 1
161	2	0	162	4 0	163	1 0	164	2 1	165	0 0	165	0 0
166	1	0	167	3 1	168	1 0	169	1 1	170	1 1	170	1 1
171	1	1	172	1 0	173	4 0	174	1 0	175	2 0	175	2 0
176	1	1	177	3 1	178	1 0	179	1 0	180	3 0	180	3 0
181	1	0	182	3 0	183	1 0	184	1 0	185	1 1	185	1 1
186	1	0	187	2 1	188	0 0	189	3 1	190	0 0	190	0 0
191	2	1	192	0 0	193	2 1	194	1 1	195	3 1	195	3 1
196	1	1	197	1 1	198	1 1	199	1 1	200	1 1	200	1 1
201	1	1	202	1 0	203	1 1	204	1 1	205	1 1	205	1 1
206	2	0	207	0 0	208	1 0	209	2 1	210	1 0	210	1 0
211	1	0	212	3 1	213	1 1	214	3 1	215	2 1	215	2 1
216	2	1	217	2 1	218	4 2	219	1 1	220	2 1	220	2 1
221	1	1	222	0 0	223	2 2	224	3 3	225	6 0	225	6 0
226	1	0	227	5 2	228	4 2	229	3 0	230	6 2	230	6 2
231	1	1	232	1 1	233	1 1	234	1 1	235	1 1	235	1 1
236	2	1	237	1 1	238	1 1	239	1 1				

NUMBER OF SHELTERS VENTILABLE BY PVK 215 (91.2 PER CENT)
 NUMBER OF SHELTERS VENTILABLE BY LFV 123 (51.4 PER CENT)
 NUMBER OF SHELTERS NOT VENTILABLE BY EITHER PVK OR LFV 21 (8.7 PER CENT)

Table 4-3

GARD SHELTER SAMPLE

SHELTERS VENTILABLE BY BOTH PVK AND LFV

SHELTER	PVK	LFV	SHELTER	PVK	LFV	SHELTER	PVK	LFV	SHELTER	PVK	LFV	SHELTER	PVK	LFV
1	4	3	6	2	1	8	3	1	9	1	1	10	1	1
11	1	1	12	1	1	14	1	1	15	4	2	16	6	2
17	3	1	19	2	1	20	1	1	21	5	2	22	4	2
23	2	1	25	3	2	26	1	1	28	3	1	31	2	1
32	3	1	33	3	1	34	2	1	35	3	1	39	2	1
42	3	1	43	4	2	45	3	1	48	3	1	49	1	1
51	2	1	54	2	1	56	2	1	62	3	4	64	6	2
65	2	1	66	2	1	67	1	1	69	3	1	70	3	1
72	2	1	73	3	1	78	3	1	79	3	1	81	3	1
82	2	1	86	2	1	89	3	1	94	2	1	99	5	2
100	6	5	101	2	1	103	4	2	107	3	1	110	2	1
111	2	1	114	1	1	115	2	1	117	3	1	122	2	1
124	2	1	125	1	1	126	4	1	127	3	1	131	2	1
132	2	1	133	2	1	138	2	1	139	2	1	141	7	3
142	1	1	144	4	2	147	10	4	149	3	1	150	2	1
156	2	1	159	3	2	160	2	1	164	2	1	167	3	1
169	1	1	170	1	1	171	1	1	176	1	1	177	3	1
185	1	1	187	2	1	189	3	1	191	2	1	193	2	1
194	1	1	195	3	1	196	1	1	197	1	1	198	1	1
199	1	1	200	1	1	201	1	1	203	1	1	204	1	1
205	1	1	209	2	1	212	3	1	213	1	1	214	3	1
215	2	1	216	2	1	217	2	1	218	4	2	219	1	1
220	2	1	221	1	1	224	3	1	227	5	2	228	4	2
230	6	2	231	1	1	232	1	1	235	1	1	236	2	1
237	1	1	238	1	1	239	1	1						

NUMBER OF SHELTERS VENTILABLE BY BOTH PVK AND LFV 123 (51.4 PER CENT)
 NUMBER OF SHELTERS IN WHICH PVK'S REQUIRED ARE GREATER THAN LFV'S 66 (35.9 PER CENT)
 TOTAL PVK'S IN SUCH SHELTERS 257
 TOTAL LFV'S IN SUCH SHELTERS 111

Table 4-4(a)

LFV CUST	GARD SHELTER SAMPLE										SHELTERS WITH LFV'S (PCT)
	RELATIVE VENTILATION COST ANALYSIS										
	...SYSTEM COST... ACTUAL	...SYSTEM COST... NORMALIZED	PKV'S	VENTILATORS LFV'S	TOTAL	SELECTED... NORMALIZED	MIXSHELTERS..... WITH PVK'S WITH LFV'S	TOTAL	VENTILABLE	
1.00	370.00	0.717	259	111	370	0.717	2.3	132	86	35.9	39.4
1.05	375.55	0.727	259	111	370	0.717	2.3	132	86	35.9	39.4
1.10	381.11	0.738	259	111	370	0.717	2.3	132	86	35.9	39.4
1.15	386.65	0.749	259	111	370	0.717	2.3	132	86	35.9	39.4
1.20	392.20	0.760	265	106	371	0.718	2.5	133	85	35.5	38.9
1.25	397.50	0.770	265	106	371	0.718	2.5	133	85	35.5	38.9
1.30	402.80	0.780	265	106	371	0.718	2.5	133	85	35.5	38.9
1.35	408.06	0.790	269	103	372	0.720	2.6	134	84	35.1	38.5
1.40	413.20	0.800	269	103	372	0.720	2.6	134	84	35.1	38.5
1.45	418.35	0.810	269	103	372	0.720	2.6	134	84	35.1	38.5
1.50	423.50	0.820	275	99	374	0.724	2.7	136	82	34.3	37.6
1.55	428.45	0.830	275	99	374	0.724	2.7	136	82	34.3	37.6
1.60	433.40	0.839	275	99	374	0.724	2.7	136	82	34.3	37.6
1.65	438.35	0.849	275	99	374	0.724	2.7	136	82	34.3	37.6
1.70	443.30	0.859	275	99	374	0.724	2.7	136	82	34.3	37.6
1.75	448.25	0.868	275	99	374	0.724	2.7	136	82	34.3	37.6
1.80	453.20	0.878	275	99	374	0.724	2.7	136	82	34.3	37.6
1.85	458.15	0.887	275	99	374	0.724	2.7	136	82	34.3	37.6
1.90	463.10	0.897	275	99	374	0.724	2.7	136	82	34.3	37.6
1.95	468.05	0.907	275	99	374	0.724	2.7	136	82	34.3	37.6
2.00	473.00	0.916	377	48	425	0.823	7.8	181	37	15.4	16.9
2.05	475.40	0.921	377	48	425	0.823	7.8	181	37	15.4	16.9
2.10	477.80	0.925	377	48	425	0.823	7.8	181	37	15.4	16.9
2.15	480.20	0.930	377	48	425	0.823	7.8	181	37	15.4	16.9
2.20	482.60	0.935	377	48	425	0.823	7.8	181	37	15.4	16.9
2.25	485.00	0.939	377	48	425	0.823	7.8	181	37	15.4	16.9
2.30	487.40	0.944	377	48	425	0.823	7.8	181	37	15.4	16.9
2.35	489.75	0.949	384	45	429	0.831	8.5	182	36	15.0	16.5
2.40	492.00	0.953	384	45	429	0.831	8.5	182	36	15.0	16.5
2.45	494.25	0.957	384	45	429	0.831	8.5	182	36	15.0	16.5
2.50	496.50	0.962	409	35	444	0.860	11.6	186	32	13.3	14.6
2.55	498.25	0.965	409	35	444	0.860	11.6	186	32	13.3	14.6
2.60	500.00	0.968	409	35	444	0.860	11.6	186	32	13.3	14.6
2.65	501.75	0.972	409	35	444	0.860	11.6	186	32	13.3	14.6
2.70	503.50	0.975	409	35	444	0.860	11.6	186	32	13.3	14.6
2.75	505.25	0.979	409	35	444	0.860	11.6	186	32	13.3	14.6
2.80	507.00	0.982	409	35	444	0.860	11.6	186	32	13.3	14.6
2.85	508.75	0.985	409	35	444	0.860	11.6	186	32	13.3	14.6
2.90	510.50	0.989	409	35	444	0.860	11.6	186	32	13.3	14.6
2.95	512.25	0.992	409	35	444	0.860	11.6	186	32	13.3	14.6

Table 4-4(b)

GARD SHELTER SAMPLE

RELATIVE VENTILATION COST ANALYSIS

LFV COST	SYSTEM COST.....		VENTILATORS SELECTED.....		PVK'S LFV'S		PVK COST 1.00		SHELTERS WITH PVK'S WITH LFV'S		SHELTERS WITH LFV'S (PCF)	
	ACTUAL	NORMALIZED	TOTAL	NORMALIZED MIX	TOTAL	NORMALIZED MIX	TOTAL	NORMALIZED MIX	TOTAL	NORMALIZED MIX	TOTAL	NORMALIZED MIX
3.00	514.00	0.996	2	510	0.988	254.0	2	216	2	216	0.8	0.9
3.05	514.10	0.996	2	510	0.988	254.0	2	216	2	216	0.8	0.9
3.10	514.20	0.996	2	510	0.988	254.0	2	216	2	216	0.8	0.9
3.15	514.30	0.996	2	510	0.988	254.0	2	216	2	216	0.8	0.9
3.20	514.40	0.996	2	510	0.988	254.0	2	216	2	216	0.8	0.9
3.25	514.50	0.997	2	510	0.988	254.0	2	216	2	216	0.8	0.9
3.30	514.60	0.997	2	510	0.988	254.0	2	216	2	216	0.8	0.9
3.35	514.70	0.997	2	510	0.988	254.0	2	216	2	216	0.8	0.9
3.40	514.80	0.997	2	510	0.988	254.0	2	216	2	216	0.8	0.9
3.45	514.90	0.997	2	510	0.988	254.0	2	216	2	216	0.8	0.9
3.50	515.00	0.998	2	510	0.988	254.0	2	216	2	216	0.8	0.9
3.55	515.10	0.998	2	510	0.988	254.0	2	216	2	216	0.8	0.9
3.60	515.20	0.998	2	510	0.988	254.0	2	216	2	216	0.8	0.9
3.65	515.30	0.998	2	510	0.988	254.0	2	216	2	216	0.8	0.9
3.70	515.40	0.998	2	510	0.988	254.0	2	216	2	216	0.8	0.9
3.75	515.50	0.999	2	510	0.988	254.0	2	216	2	216	0.8	0.9
3.80	515.60	0.999	2	510	0.988	254.0	2	216	2	216	0.8	0.9
3.85	515.70	0.999	2	510	0.988	254.0	2	216	2	216	0.8	0.9
3.90	515.80	0.999	2	510	0.988	254.0	2	216	2	216	0.8	0.9
4.00	516.00	1.000	0	516	1.000	254.0	0	218	0	218	0.0	0.0
4.05	516.00	1.000	0	516	1.000	254.0	0	218	0	218	0.0	0.0
4.10	516.00	1.000	0	516	1.000	254.0	0	218	0	218	0.0	0.0
4.15	516.00	1.000	0	516	1.000	254.0	0	218	0	218	0.0	0.0
4.20	516.00	1.000	0	516	1.000	254.0	0	218	0	218	0.0	0.0
4.25	516.00	1.000	0	516	1.000	254.0	0	218	0	218	0.0	0.0
4.30	516.00	1.000	0	516	1.000	254.0	0	218	0	218	0.0	0.0
4.35	516.00	1.000	0	516	1.000	254.0	0	218	0	218	0.0	0.0
4.40	516.00	1.000	0	516	1.000	254.0	0	218	0	218	0.0	0.0
4.45	516.00	1.000	0	516	1.000	254.0	0	218	0	218	0.0	0.0
4.50	516.00	1.000	0	516	1.000	254.0	0	218	0	218	0.0	0.0
4.55	516.00	1.000	0	516	1.000	254.0	0	218	0	218	0.0	0.0
4.60	516.00	1.000	0	516	1.000	254.0	0	218	0	218	0.0	0.0
4.65	516.00	1.000	0	516	1.000	254.0	0	218	0	218	0.0	0.0
4.70	516.00	1.000	0	516	1.000	254.0	0	218	0	218	0.0	0.0
4.75	516.00	1.000	0	516	1.000	254.0	0	218	0	218	0.0	0.0
4.80	516.00	1.000	0	516	1.000	254.0	0	218	0	218	0.0	0.0
4.85	516.00	1.000	0	516	1.000	254.0	0	218	0	218	0.0	0.0
4.90	516.00	1.000	0	516	1.000	254.0	0	218	0	218	0.0	0.0
4.95	516.00	1.000	0	516	1.000	254.0	0	218	0	218	0.0	0.0
5.00	516.00	1.000	0	516	1.000	254.0	0	218	0	218	0.0	0.0

void because of future relative cost variations between the PV and the LFV. (Besides, the exact cost of a practical, production version of a LFV is not known at present). LFV costs less than a ratio of 1.0 or 100% of the PV cost were not considered since it is highly unlikely that the LFV will be less expensive than the PV.

Using this cost basis, each shelter was analyzed to determine whether it would be more economical to ventilate with a PV or with a LFV. System costs for the entire sample and the normalized system cost, i.e., the system cost expressed as a fraction of the maximum system cost found in the analysis were then computed for the different LFV costs. In addition, the total number of PV's and LFV's were tabulated and the ventilator mix, i.e. the ration of PV's to LFV's, determined. Shelters ventilable with LFV's economically were also expressed as a percentage of the total shelters (239) and the ventilable shelters (218) in the sample.

Based on the above analyses the following results applicable to the nationwide system of basement fallout shelters in the NFSS were obtained:

- 1) Number of shelters ventilable by PV: 91.3%
- 2) Number of shelters ventilable by LFV: 51.4%
- 3) Number of shelters not ventilable by either PV or LFV: 8.7%
- 4) For a relative LFV to PV cost of \$1.50 to \$1.00 (a reasonable estimate):
 - a) Shelters in which LFV's can be more advantageously used (i.e., would be less expensive) than PV's: 34.3%
 - b) Overall savings in cost compared to utilizing PV's only: 18.0%
 - c) Optimum mix of PV to LFV: 2.7:1
 - d) Reduction in the number of units procured for this mix as compared to utilizing PV's only:* 27.6%

* Each PV or LFV is considered a single unit.

From these results it can be concluded that if the LFV cost does not exceed 150% of the PV cost, the use of the LFV in 34.3% of the NFSS basement shelters would result in an overall savings of 18%. For other LFV costs, the percentage of the NFSS basement shelters in which it would replace PV's at an overall savings in cost, can be obtained from Tables 4-4(a) and 4-4(b).

SECTION 5

RECOMMENDATIONS

Based on the research performed in the following areas:

- 1) Design improvement of the Kearny pump
- 2) Determination of the blast vulnerability of OCD-provided shelter supplies, and
- 3) Applicability of large fan ventilators to shelters,

the following is recommended:

1) Kearny pump

- a) Replace the Ionomer flaps with flaps of Griffolyn #55 of the same design as the previous to eliminate the wear problem.
- b) Investigate a substitute for the metal hinge wires of the KP flaps to eliminate a potentially dangerous component to the shelterees, in case a shelter is subject to blast waves.

2) Pedal ventilator

Continue use of present design and packaging since they are satisfactory from a blast resistance standpoint.*

3) Large fan ventilator

A practical, production version of the LFV, preferably with a 60" diameter fan, would reduce the overall cost of providing ventilation to the NFSS basement shelters. Since overall savings would depend on the cost of the LFV, primary design emphasis should be on low manufactured cost.

* Incident blast overpressure at shelter entrance of 5 psi.

4) Other OCD supplies

Continue use of the present packaging of the radiation kit, survival biscuits and sanitation kit since they are satisfactory from a blast resistant standpoint.

5) Placement of supplies in shelters

- a) Place drag-sensitive items away from the likely path of a blast wave, such as under stairways.
- b) Store packaged items against walls in areas where they will be subject to compression only rather than translation. The walls in these areas should be smooth (no protuberances) to prevent possible damage to the supplies.
- c) Store impact-sensitive items, such as radiation kits, near the floor to prevent damage due to dropping.

SECTION 6

REFERENCES

1. ASHRAE Guide and Data Book, Equipment, Published by the American Society of Heating, Refrigerating and Air-Conditioning Engineers, 1969.
2. Heat Sealing Polyolefin Films, Fourth Edition, U. S. Industrial Chemicals Co., Division of National Distillers and Chemical Corporation, 1965.
3. Primacord Detonating Cord, Ensign Bickford Company, 1963.
4. Bettge, D.A. COTR, Office of Civil Defense, OSA, Private Communication, July 1968.
5. Glasstone, S., ed., The Effects of Nuclear Weapons, Prepared by the U. S. Department of Defense, Published by the U. S. Atomic Energy Commission, April 1962.
6. Gorecki, E.W., and Jago, A. G., Collapsible Water Container Kit, Report 1478, OCD Contract No. DAHC20-68-C-0123, Work Unit 1433E, GARD, General American Transportation Corporation, January 1971.
7. Hill, E. L., Caldwell, J. G., and Grogan, W. K., Determination of Shelter Configuration for Ventilation, Report R-OU-177, OCD Contract No. OCD-PS-64-56, Work Unit 1235A, The Research Triangle Institute, July 1965.
8. Kapil, A. L., and Rathmann, C. E., Shelter Ventilator Studies, Report 1477-1, OCD Contract No. DAHC20-68-C-0123, Work Unit 1423D, GARD, General American Transportation Corporation, January 1971.
9. Kapil, A. L., Sitko, H. M., and Buday, J. M., Ventilation Kits, Report 1477, OCD Contract No. DAHC20-68-C-0123, Work Unit 1423D, GARD, General American Transportation Corporation: November 1969.
10. Lappala, R. P. et al., Non-Tacky Tear Resistant Material, U. S. Patent 3,214,320, October 26, 1965.
11. Melichar, J. F., Air-Blast-Induced Aerodynamic Effects in Blast-Slanted Basement Shelters, Report URS 692-3, OCD Contract No. DAHC20-67-C-0136, Work Unit 1126E, URS Research Company, January 1969.
12. Rathmann, C. E., Configuration Effects on Ventilation in Belowgrade Shelters, Report 1476, OCD Contract No. DAHC20-68-C-0123, Work Unit 1217C, GARD, General American Transportation Corporation, August 1969.
13. Rathmann, C. E., Air Distribution in Shelters Due to Kearny Pumps and Pedal Ventilators, Report 1476-1, OCD Contract No. DAHC20-68-C-0123, Work Unit 1217C, GARD, General American Transportation Corporation, August 1970.

14. Rathmann, C. E., Analytical Studies of Shelter Environments, Report 1475-2, OCD Contract No. DAHC20-68-C-0123, Work Unit 1215B, GARD, General American Transportation Corporation, December 1970.
15. Willoughby, A. B., Wilton, C., and Gabrielsen, B., Development and Evaluation of a Shock Tunnel Facility for Conducting Full-Scale Tests of Loading Response and Debris Characteristics of Structural Elements, Report URS 680-2, SRI Subcontract Nos. 11229(6300A-320), 11618(3600A-250, Work Units 3313B, 1123D, URS Research Company, December 1967.
16. Wilton, C., OCD Ventilating Equipment Tests, Report URS 709-1, URS Research Company, June 1969.

APPENDIX A

Pressure Profiles of Blast Tests

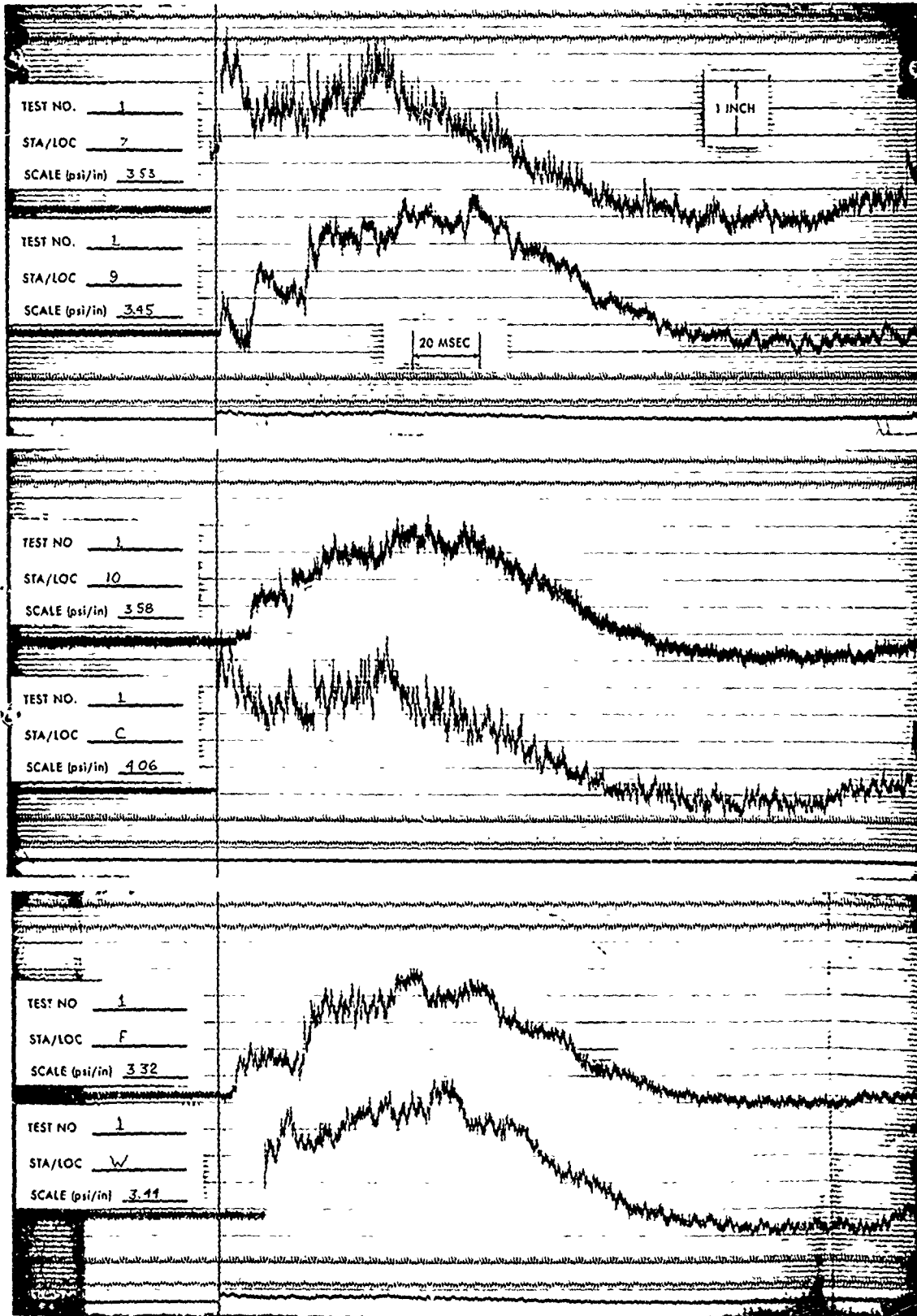

Test 1

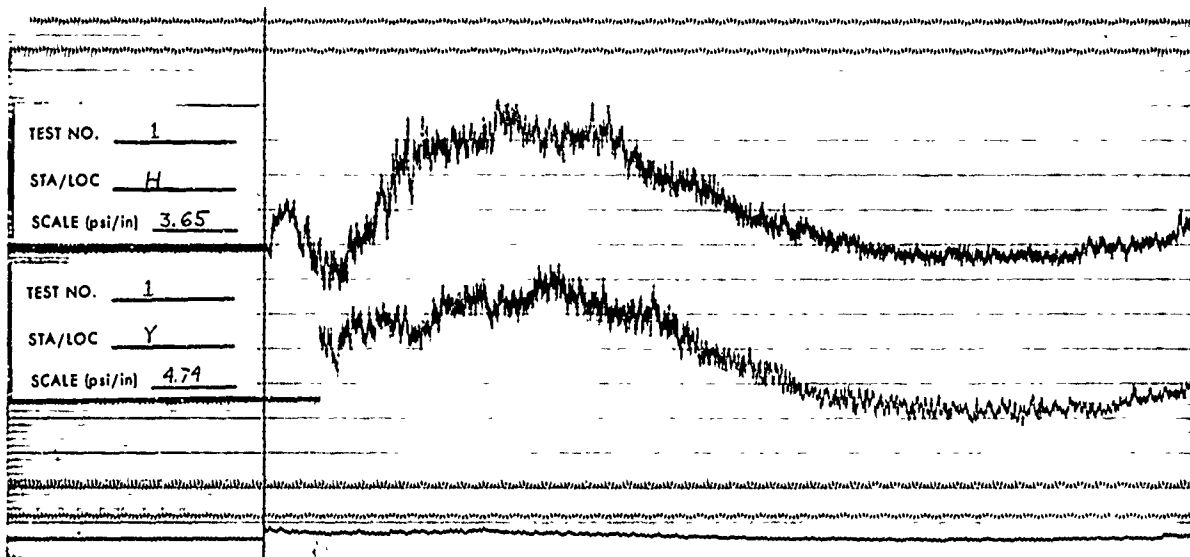
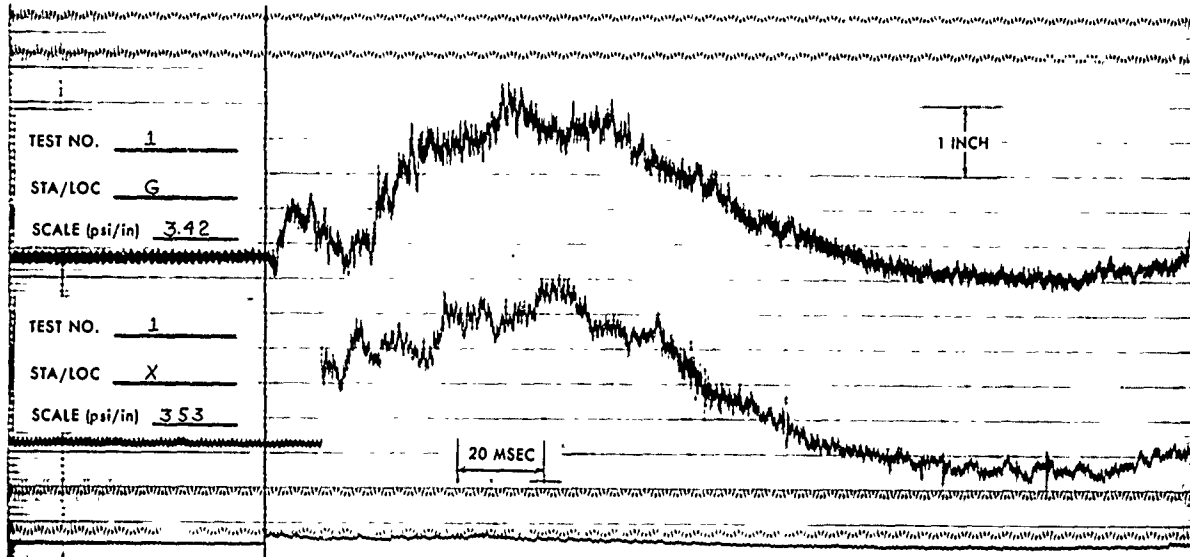

Test 1 (Continued)

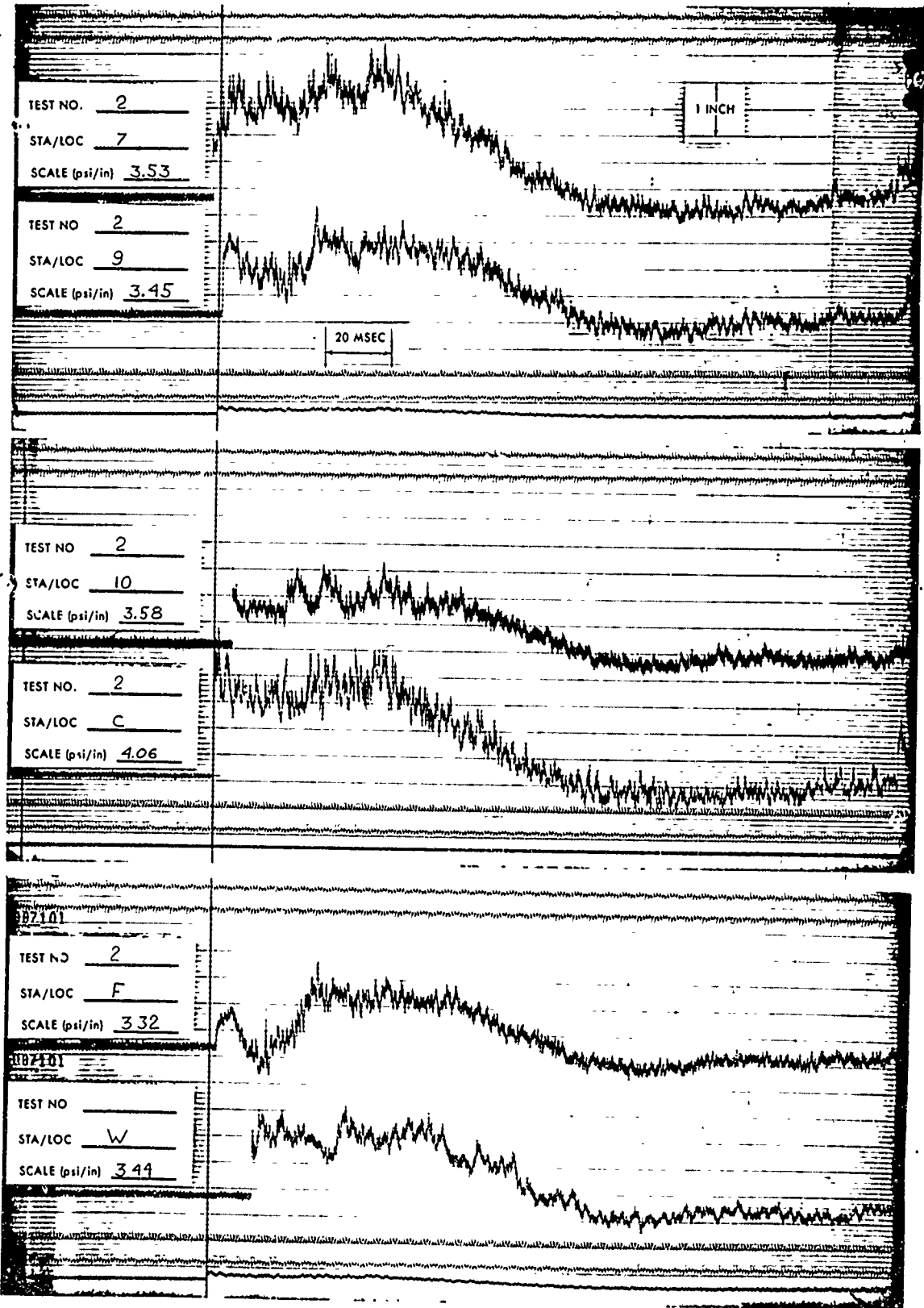

Test 2

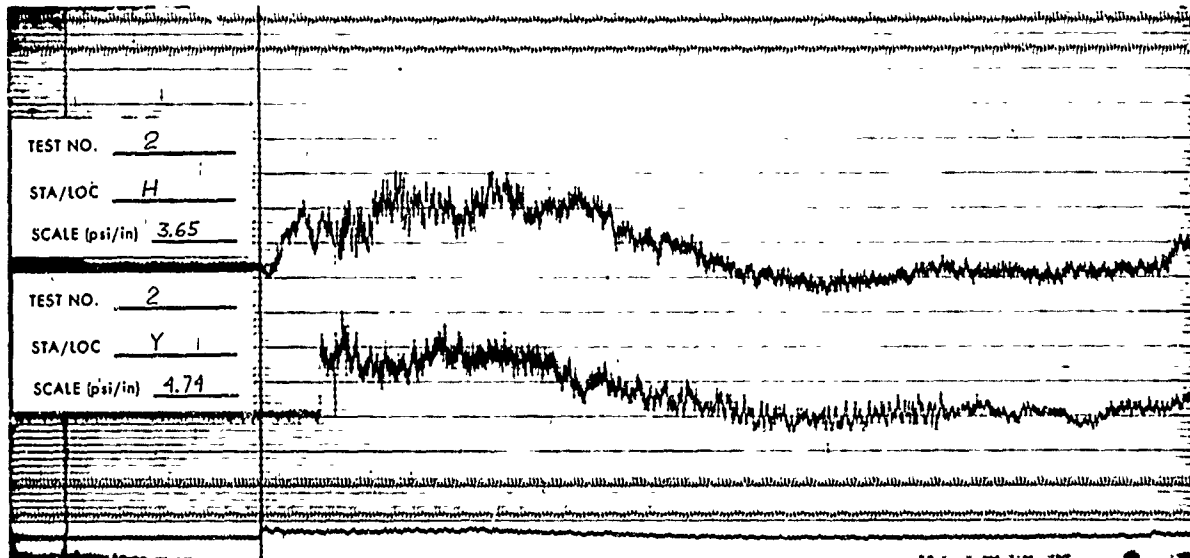
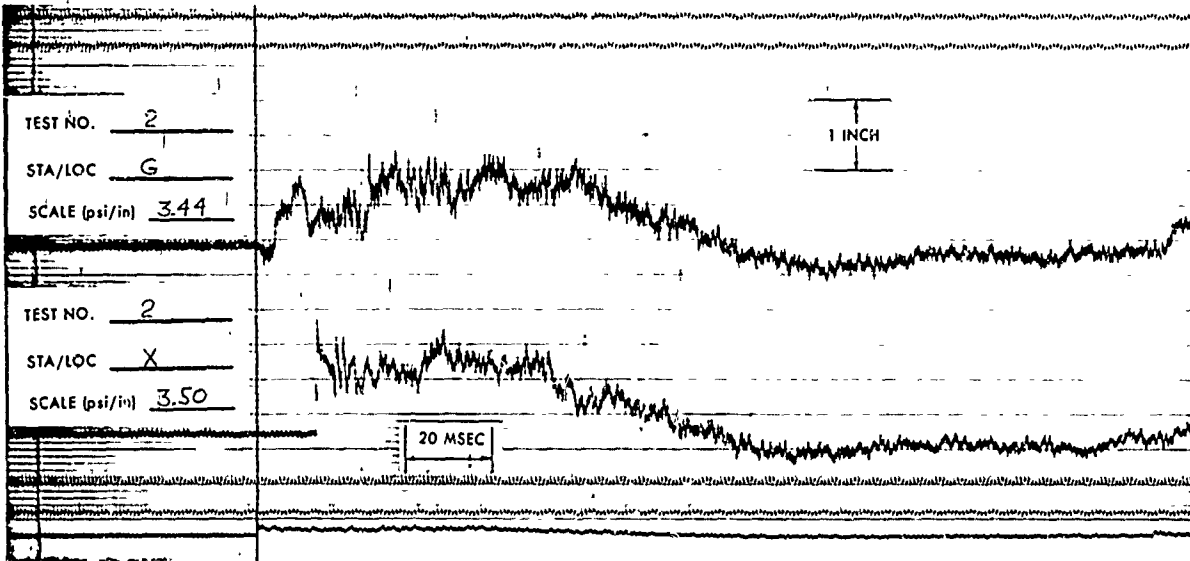

Test 2 (Continued)

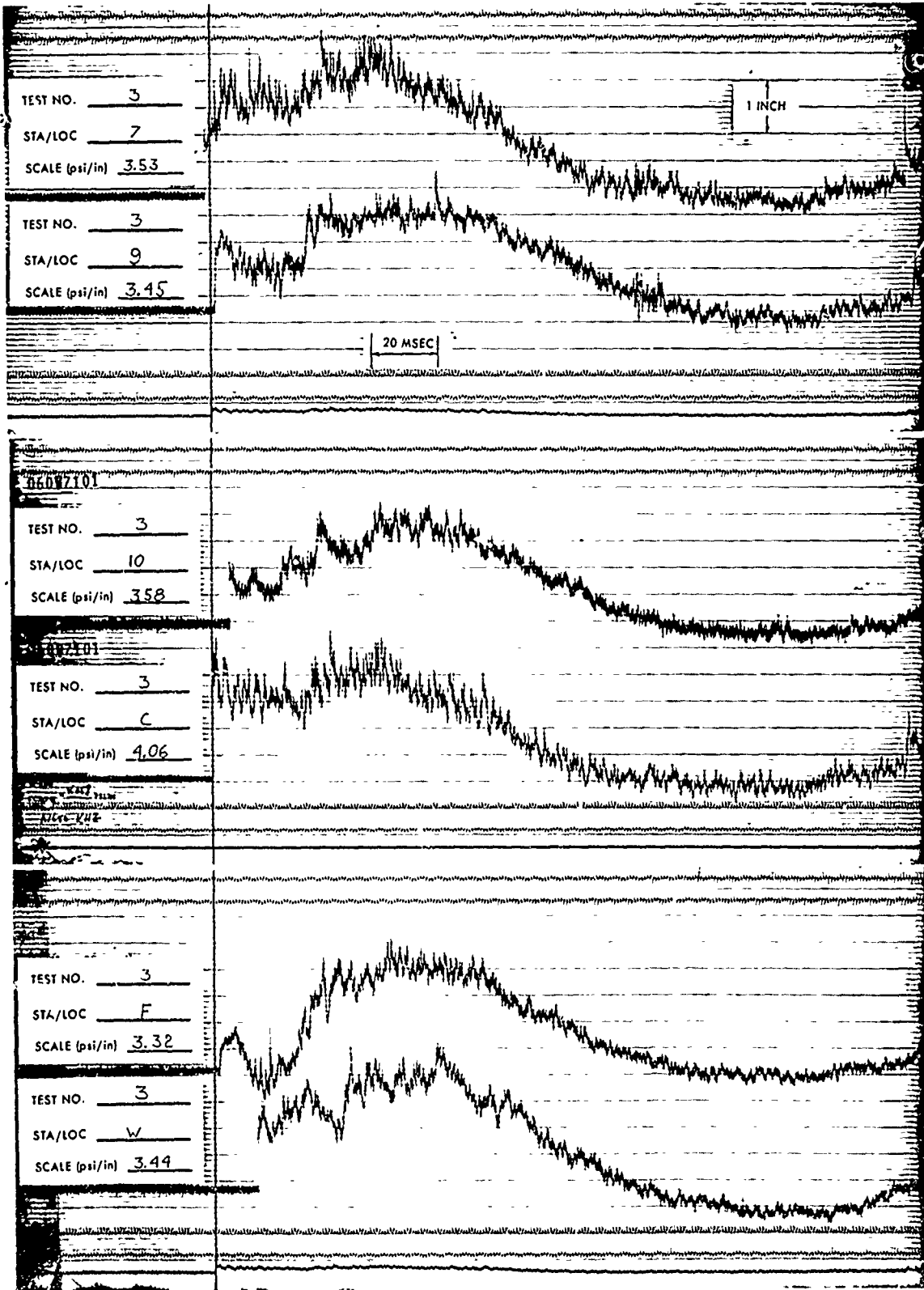

Test 3

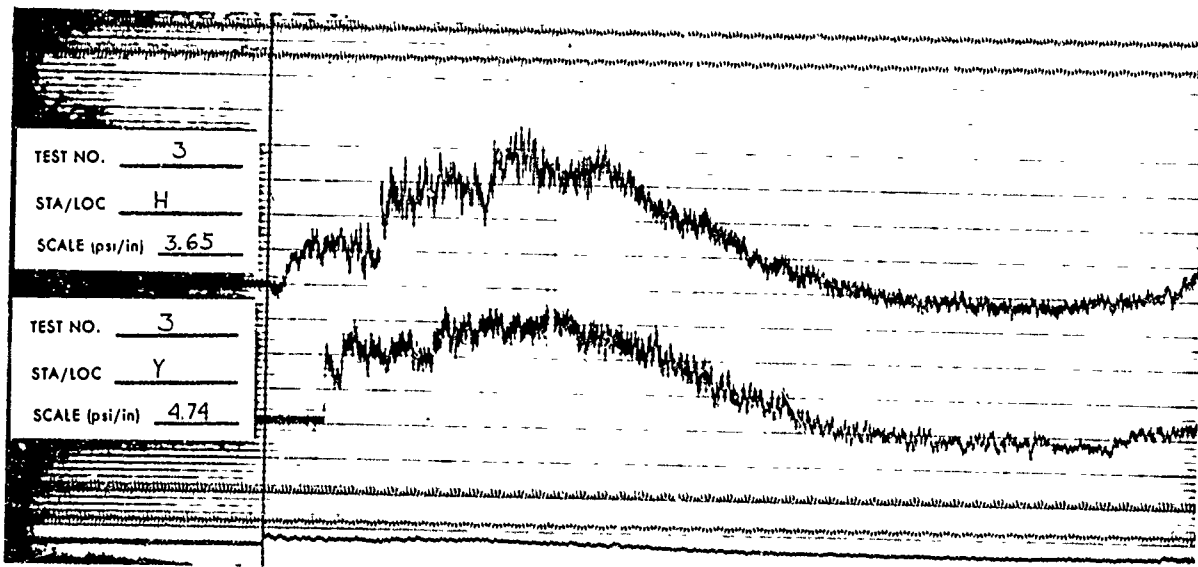
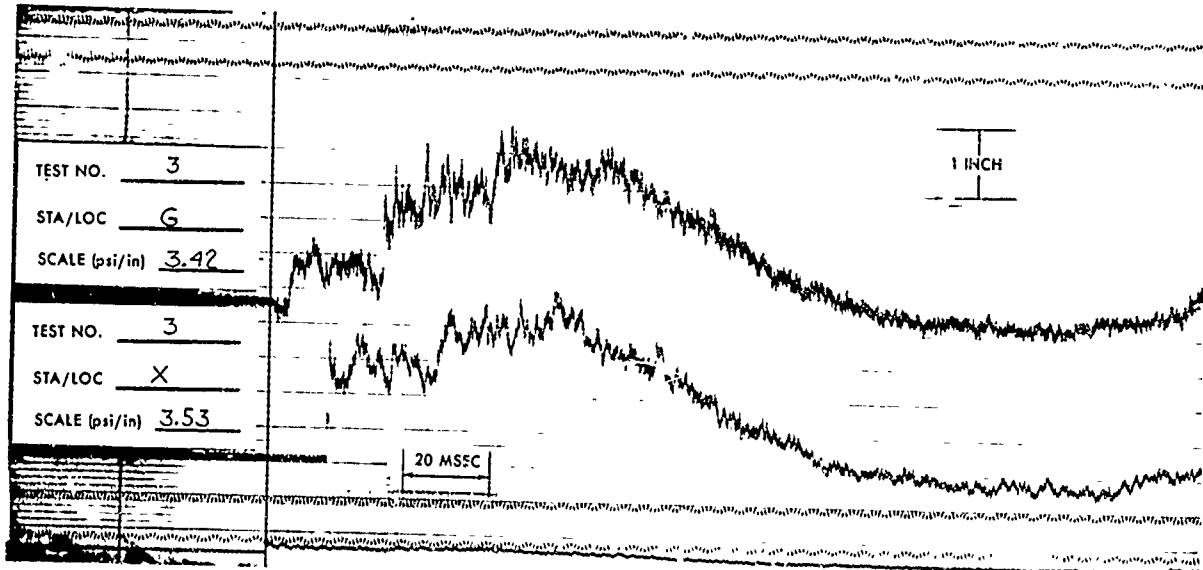

Test 3 (Continued)

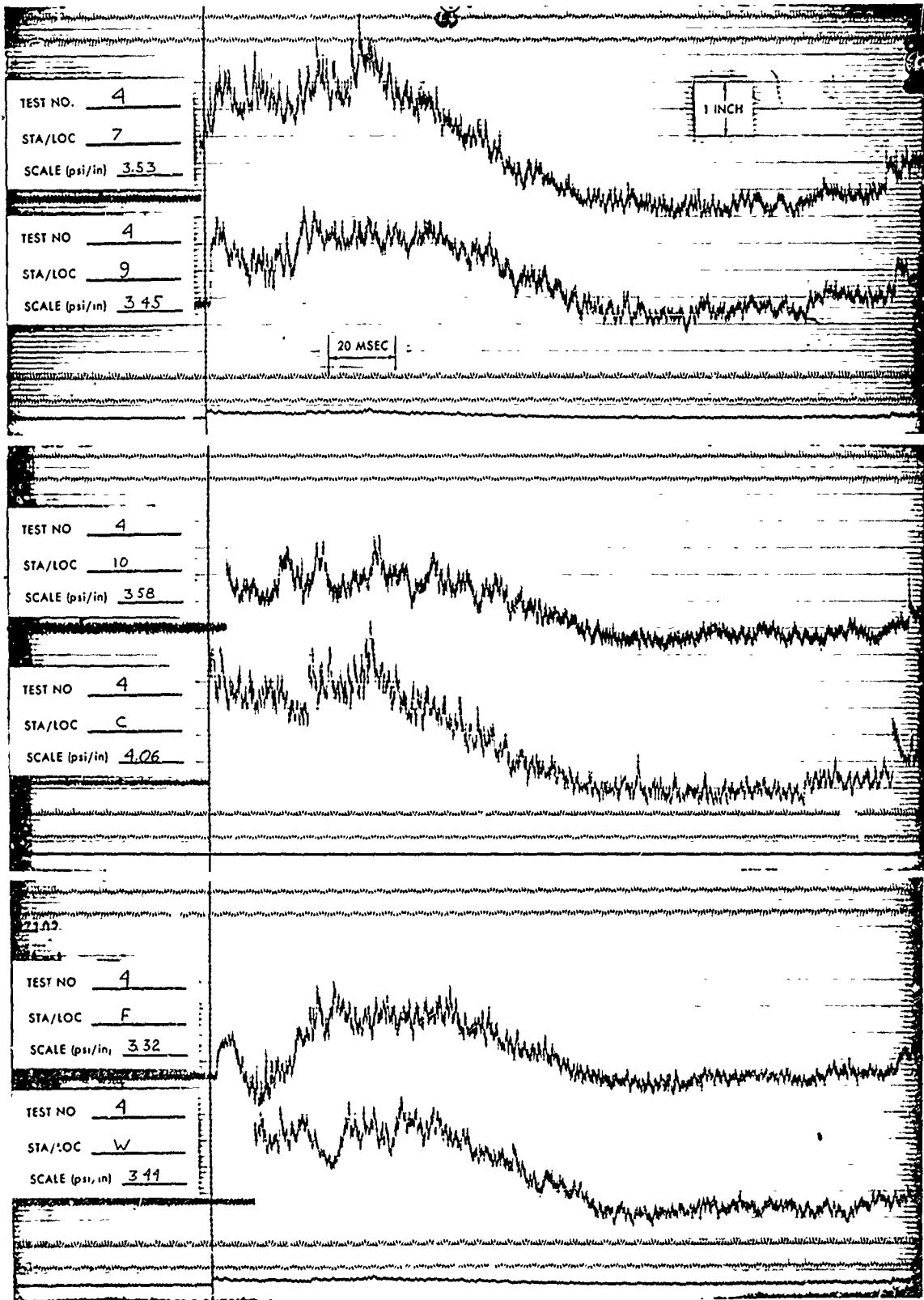

Test 4

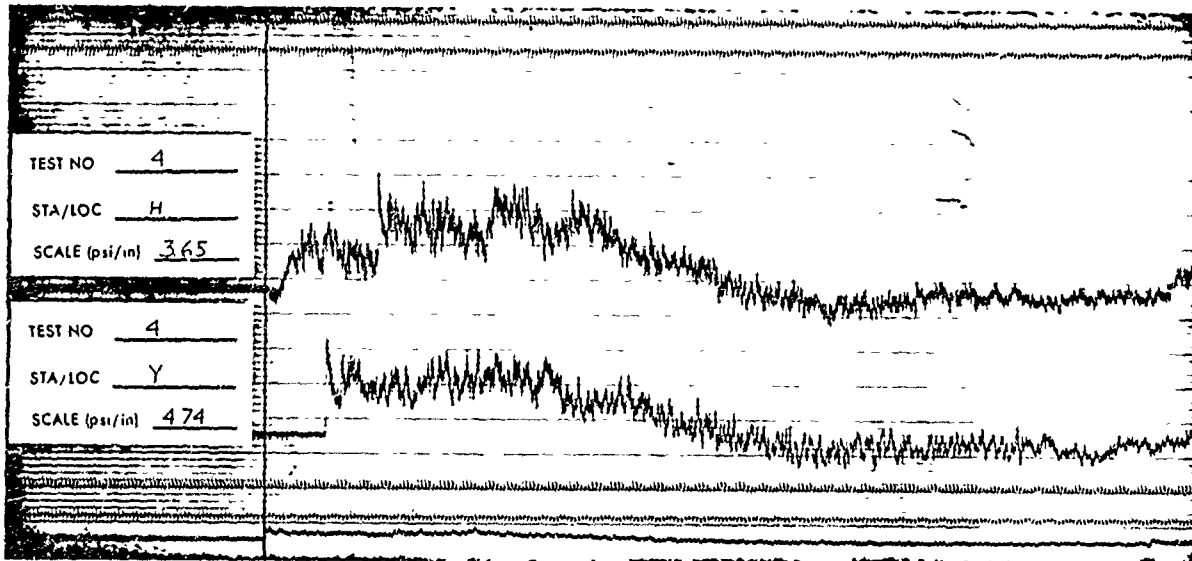
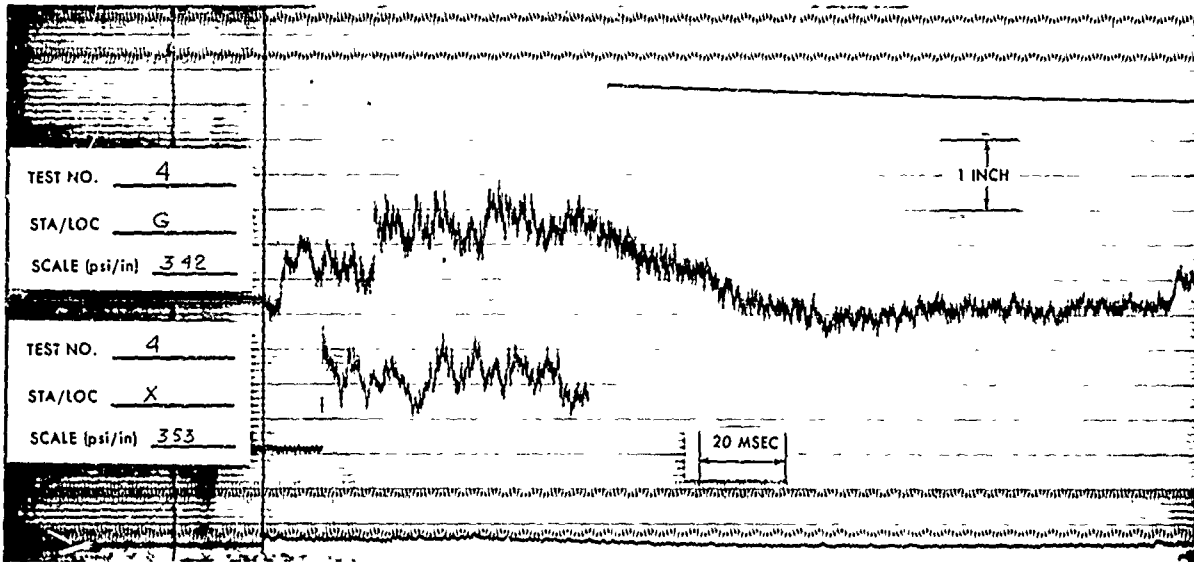

Test 4 (Continued)

APPENDIX B

GARD Sample Shelter Characteristics

GARD SHELTER SAMPLE

The shelter type designations in the accompanying list of GARD sample shelters, represent the following shelter configurations:

Shelter Type	Shelter Configuration
1	Basic single room a. Single room b. Single room + 1 much smaller room c. Winding corridor
2	Large area with small adjoining rooms
3	Partitioned into rooms of comparable size a. Two rooms b. Three rooms c. Four rooms d. More than four rooms
4	Corridor with rooms off corridor
5	Corridor (with rooms off it) joining 2 large areas
6	Complex configuration with large number of rooms that form combinations of the preceding categories

GARD SHELTER SAMPLE

SHELTER NO.	TYPE	ZONE	TOTAL AREA	FLOW-THRU ROOMS	DEAD-END ROOMS	DOORS	INTERIOR DOORS	WINDOWS	DOORS	WINDOWS	ELEVATORS	STAIRS	VENTS
1	3	15.0	8505.	1	4	5	0	0	0	0	3	2	0
2	1	15.0	3840.	0	1	1	0	0	0	0	0	1	0
3	3	15.0	14650.	1	2	4	0	0	0	0	1	1	2
4	5	15.0	6366.	2	3	5	0	0	0	0	0	3	5
5	3	15.0	3420.	2	1	2	0	0	0	0	1	1	1
6	6	10.0	7351.	2	4	5	0	0	0	0	0	1	1
7	3	10.0	1920.	1	2	2	0	0	0	0	1	1	1
8	5	10.0	10835.	3	20	23	0	0	0	0	2	2	0
9	3	10.0	3200.	4	0	3	0	0	0	0	1	1	0
10	3	10.0	3540.	4	4	6	0	0	0	0	1	1	0
11	3	10.0	3215.	7	0	9	0	0	0	0	1	4	0
12	1	10.0	1605.	2	0	2	0	0	0	0	1	1	1
13	1	10.0	8200.	1	0	1	0	0	0	0	1	0	0
14	2	10.0	3695.	2	2	3	0	0	0	0	2	1	0
15	1	10.0	12615.	2	0	3	0	0	0	0	2	2	0
16	2	7.5	29550.	1	0	15	0	0	0	0	4	3	0
17	1	7.5	13025.	1	1	4	0	0	0	0	2	4	0
18	6	7.5	4137.	5	10	19	0	0	0	0	2	3	0
19	2	7.5	5700.	3	6	8	0	0	0	0	2	3	0
20	3	7.5	4175.	3	1	3	0	0	0	0	2	1	0
21	3	20.0	9235.	2	0	4	0	0	0	0	2	1	0
22	6	20.0	7545.	1	14	21	0	0	0	0	3	2	0
23	2	10.0	5180.	2	4	5	0	0	0	0	1	2	0
24	3	10.0	3250.	0	9	9	0	0	0	0	0	2	0
25	6	10.0	8300.	5	17	30	0	0	0	0	1	2	0
26	1	10.0	3200.	1	0	0	0	0	0	0	0	1	1
27	1	10.0	1705.	1	1	1	0	0	0	0	1	1	0
28	2	20.0	4885.	6	3	9	0	0	0	0	1	1	0
29	3	20.0	2855.	1	3	3	0	0	0	0	0	3	2
30	2	10.0	6480.	6	3	14	0	0	0	0	0	3	0
31	6	10.0	7455.	2	7	12	0	0	0	0	2	2	0
32	2	10.0	10680.	3	6	10	0	0	0	0	2	2	0
33	2	10.0	12030.	2	9	12	0	0	0	0	2	5	1
34	3	10.0	4265.	4	9	16	0	0	0	0	3	1	1
35	5	7.5	13960.	4	5	6	0	0	0	0	2	4	0
36	5	7.5	3205.	6	1	5	0	0	0	0	0	3	3
37	6	7.5	2925.	2	10	20	0	0	0	0	0	2	0
38	1	7.5	39000.	1	0	0	0	0	0	0	1	2	0
39	1	7.5	7100.	1	1	1	0	0	0	0	1	1	0
40	1	15.0	19000.	1	0	0	0	0	0	0	0	4	0
41	4	15.0	18930.	3	15	17	0	0	0	0	4	4	0
42	3	15.0	6835.	2	2	4	0	0	0	0	2	4	0
43	2	15.0	9420.	4	13	18	0	0	0	0	4	3	0
44	6	15.0	9175.	1	19	24	0	0	0	0	1	2	0
45	1	10.0	11470.	1	1	4	0	0	0	0	2	3	0
46	1	10.0	15590.	2	0	1	0	0	0	0	0	4	0
47	4	10.0	3915.	1	3	6	0	0	0	0	2	2	3
48	1	10.0	8870.	1	1	1	0	0	0	0	0	2	0
49	3	10.0	2340.	0	1	1	0	0	0	0	1	1	0
50	1	10.0	5600.	1	0	0	0	0	0	0	0	2	0

GARD SHELTER SAMPLE

SHELTER NO.	TYPE	ZONE	TOTAL AREA	FLOW-THRU ROOMS	DEAD-END ROOMS	DOORS	INTERIOR WINDOWS	DOORS	INTERIOR WINDOWS	DOORS	WINDOWS	ELEVATORS	STAIRS	VENTS
51	3	10.0	7234.	0	4	3	0	1	0	0	0	0	1	1
52	1	10.0	2920.	1	0	0	0	0	0	0	8	0	2	0
53	3	10.0	3502.	2	7	8	0	0	0	0	10	0	2	0
54	1	10.0	4950.	1	1	1	0	4	1	1	1	2	2	0
55	6	25.0	3135.	0	7	6	0	0	0	0	0	1	1	0
56	1	10.0	5800.	1	1	1	0	0	0	0	0	1	1	0
57	3	10.0	2300.	1	1	1	0	0	0	0	2	1	1	1
58	1	10.0	16600.	1	0	0	0	0	0	0	0	1	2	0
59	3	10.0	7570.	2	2	3	0	0	0	0	0	0	2	0
60	3	10.0	9475.	3	0	4	0	0	0	0	0	0	2	0
61	3	10.0	3945.	2	0	1	0	0	0	0	4	1	1	0
62	3	10.0	9350.	2	1	0	0	0	0	0	0	2	3	0
63	3	10.0	13770.	5	1	4	0	0	0	0	0	2	2	0
64	6	10.0	22325.	7	14	18	0	5	0	0	0	0	5	0
65	1	10.0	4800.	1	0	0	0	0	0	0	3	1	1	0
66	6	10.0	7000.	7	6	20	0	1	0	0	12	4	4	1
67	3	10.0	3935.	5	1	5	0	1	0	0	17	3	1	0
68	2	10.0	13600.	0	11	10	0	1	0	0	0	1	1	0
69	4	10.0	9505.	13	3	21	0	2	0	1	26	3	3	0
70	2	10.0	8845.	8	7	18	0	2	0	2	18	2	2	1
71	3	10.0	8550.	2	2	4	0	1	0	1	0	1	1	0
72	3	10.0	7420.	2	1	2	0	0	0	3	0	1	1	0
73	1	10.0	10750.	1	0	0	0	0	0	0	9	2	2	0
74	1	10.0	19350.	1	0	0	0	0	0	0	5	1	1	0
75	1	10.0	13740.	1	0	0	0	0	0	0	0	0	4	0
76	1	15.0	8290.	2	2	8	0	1	0	0	0	1	1	0
77	6	15.0	15222.	2	5	5	0	0	0	0	0	1	2	0
78	2	15.0	6299.	2	4	5	0	0	0	0	3	1	1	0
79	3	15.0	6360.	2	0	1	0	0	0	0	6	1	1	0
80	6	15.0	35810.	4	3	10	0	0	0	0	0	2	1	0
81	6	7.5	11855.	4	14	17	0	0	0	0	0	3	3	0
82	2	7.5	5645.	1	5	5	0	0	0	0	0	2	2	0
83	6	7.5	10590.	2	13	13	0	2	0	0	0	0	4	0
84	3	7.5	3485.	1	4	5	0	0	0	0	0	0	2	0
85	3	7.5	8400.	2	3	2	0	0	0	0	1	4	4	0
86	3	7.5	10165.	1	3	3	0	0	0	0	0	1	1	0
87	1	7.5	6400.	1	1	0	0	0	0	0	0	0	1	0
88	1	7.5	13500.	1	1	1	0	0	0	0	0	1	1	0
89	1	7.5	14800.	1	1	1	0	0	0	0	0	1	1	0
90	2	10.0	5355.	1	7	7	0	0	0	0	1	2	2	0
91	3	7.5	10600.	2	5	0	0	0	0	0	0	0	4	0
92	2	7.5	4725.	1	0	5	0	0	0	0	0	2	2	0
93	3	10.0	4240.	3	3	1	0	0	0	0	0	0	2	0
94	6	10.0	6050.	1	7	9	0	0	0	0	0	2	2	0
95	3	10.0	2250.	3	1	3	0	0	0	0	2	1	1	0
96	6	20.0	13335.	6	9	13	0	0	0	0	0	1	2	0
97	2	20.0	2720.	0	3	2	0	0	0	0	0	0	1	0
98	3	20.0	2880.	1	1	1	0	0	0	0	0	0	1	0
99	1	10.0	17710.	1	0	0	0	0	0	0	3	2	2	0
100	2	10.0	21555.	6	5	11	0	0	0	0	0	3	2	0

GARD SHELTER SAMPLE

SHELTER NO.	TYPE	ZONE	TOTAL AREA	FLOW-THRU ROOMS	DEAD-END ROOMS	DOORS	INTERIOR DOORS	WINDOWS	DOORS	WINDOWS	ELEVATORS	STAIRS	VENTS
101	1	10.0	6930.	1	1	1	0	0	0	0	1	1	1
102	6	10.0	3710.	0	8	9	0	0	0	0	0	2	0
103	6	10.0	13300.	7	20	30	0	0	0	3	3	3	1
104	2	25.0	18570.	3	1	3	0	0	0	2	3	0	0
105	6	7.5	7665.	11	1	11	0	0	16	0	1	1	0
106	2	7.5	16805.	4	6	11	0	0	4	0	1	1	0
107	4	7.5	14300.	11	13	17	0	0	11	2	0	0	0
108	2	7.5	3735.	5	0	4	0	0	8	0	1	1	0
109	2	7.5	3790.	2	2	3	0	0	1	0	2	2	0
110	2	10.0	4400.	2	4	5	0	0	0	1	1	1	0
111	2	10.0	6665.	3	11	13	0	0	0	1	2	1	1
112	3	10.0	4225.	0	8	7	0	0	0	0	1	1	0
113	6	10.0	8085.	1	6	7	0	0	0	1	1	1	0
114	2	10.0	2865.	1	6	8	0	0	1	1	1	1	0
115	3	15.0	4060.	4	1	1	0	0	0	6	5	4	4
116	3	15.0	6290.	0	3	3	0	0	0	1	1	1	0
117	1	15.0	7730.	0	3	2	0	0	0	0	1	1	0
118	2	15.0	1935.	0	4	3	0	0	0	0	1	1	0
119	2	15.0	5630.	1	3	3	0	0	0	1	1	1	0
120	3	15.0	565.	1	1	3	0	0	4	0	1	1	0
121	1	15.0	1400.	0	2	1	0	0	0	0	1	1	0
122	6	15.0	3280.	3	8	16	0	0	0	2	4	4	0
123	2	10.0	4375.	2	2	3	0	0	9	0	1	1	0
124	6	10.0	6585.	4	10	14	0	0	0	3	2	4	0
125	6	10.0	3100.	3	4	4	0	0	5	1	4	6	0
126	6	10.0	12530.	8	1	15	0	0	23	3	3	3	0
127	6	10.0	10085.	11	3	23	0	10	32	0	2	6	0
128	6	10.0	8475.	5	3	3	0	0	8	0	2	2	0
129	6	10.0	14965.	6	8	14	0	0	0	0	5	5	0
130	3	10.0	5250.	9	0	8	0	0	38	0	1	1	0
131	3	10.0	5915.	10	1	9	0	0	21	1	2	2	0
132	6	10.0	5400.	3	4	8	0	0	0	1	2	2	0
133	6	10.0	8155.	10	0	10	0	0	18	1	1	1	0
134	1	10.0	2500.	1	1	1	0	0	3	0	1	1	0
135	6	10.0	2520.	0	9	6	0	0	0	0	2	2	0
136	6	10.0	5120.	8	7	14	0	0	6	0	2	2	0
137	1	10.0	1460.	1	0	1	0	0	2	0	1	1	0
138	2	10.0	6550.	3	0	1	0	0	4	0	3	3	0
139	1	10.0	5165.	1	1	1	0	0	0	1	1	1	0
140	2	10.0	3090.	0	4	4	0	0	0	0	1	1	0
141	3	10.0	28965.	3	3	11	0	0	8	5	4	4	0
142	1	10.0	3900.	2	0	1	0	0	8	1	2	2	0
143	2	15.0	8810.	0	7	6	0	0	0	1	1	1	0
144	6	15.0	10275.	7	11	17	0	0	0	1	3	3	0
145	6	15.0	6520.	4	4	13	0	0	0	1	2	2	0
146	6	15.0	36435.	6	14	16	0	0	3	2	4	4	2
147	4	15.0	26205.	34	14	28	0	0	62	3	7	7	0
148	6	10.0	20385.	5	13	15	0	0	0	1	3	3	0
149	6	10.0	8995.	3	8	11	0	0	0	3	1	1	2
150	2	10.0	7170.	0	4	3	0	0	0	1	1	1	0

GARD SHELTER SAMPLE

SHELTER NO.	TYPE	ZONE	TOTAL AREA	FLOW-THRU ROOMS	DEAD-END ROOMS	INTERIOR DOORS	INTERIOR WINDOWS	DOORS	WINDOWS	ELEVATORS	STAIRS	VENTS
201	1	10.0	870.	1	1	1	0	2	2	0	1	0
202	1	10.0	840.	1	0	0	0	0	2	0	1	0
203	5	10.0	1140.	2	3	6	0	2	3	0	1	0
204	3	10.0	2476.	3	1	3	0	3	2	0	0	0
205	1	10.0	436.	1	1	1	0	1	0	0	0	0
206	2	15.0	3343.	4	2	5	0	0	17	0	1	0
207	3	15.0	4840.	2	5	6	0	0	4	0	1	0
208	3	15.0	1600.	0	2	1	0	0	0	0	1	0
209	1	15.0	3175.	1	2	2	0	0	0	1	1	0
210	1	15.0	610.	1	0	0	0	0	2	0	1	0
211	2	15.0	575.	2	0	2	0	0	2	0	1	0
212	6	10.0	11425.	1	7	7	0	0	0	2	1	0
213	1	10.0	655.	1	0	0	0	1	4	0	1	0
214	6	10.0	9415.	3	6	8	0	0	0	2	2	0
215	6	10.0	4465.	6	8	14	0	0	0	1	5	0
216	3	10.0	4800.	1	2	2	0	0	0	3	2	0
217	1	10.0	4800.	2	0	1	0	0	0	3	1	1
218	6	10.0	13205.	8	17	29	0	1	6	2	1	1
219	2	10.0	3000.	2	0	3	0	0	0	1	1	0
220	6	10.0	4455.	4	8	12	0	1	3	1	2	0
221	1	10.0	2688.	2	0	1	0	0	0	4	3	0
222	5	10.0	8000.	0	10	15	0	0	0	0	1	0
223	1	10.0	3760.	1	1	1	0	0	2	1	1	0
224	2	10.0	8922.	2	7	6	0	3	0	5	0	0
225	6	10.0	13596.	1	5	12	0	0	0	1	4	3
226	1	10.0	744.	0	2	2	0	0	0	0	0	0
227	6	10.0	19412.	43	26	66	0	7	0	4	10	8
228	6	10.0	13743.	16	7	24	0	0	53	1	8	3
229	6	10.0	10682.	9	5	15	0	0	4	0	5	3
230	6	10.0	23203.	42	16	62	0	1	98	6	14	0
231	6	10.0	3700.	6	6	12	0	0	0	3	2	0
232	3	10.0	720.	1	2	3	0	0	5	1	2	0
233	6	10.0	1090.	2	2	3	0	0	1	0	2	0
234	3	10.0	3163.	4	2	5	0	0	0	0	1	1
235	3	10.0	2207.	4	0	2	0	0	2	2	2	0
236	6	10.0	6548.	9	7	15	0	5	16	0	2	0
237	6	10.0	3756.	4	5	6	0	0	4	1	2	0
238	6	10.0	1660.	0	9	8	0	2	4	0	2	0
239	1	10.0	978.	2	0	1	0	1	0	0	2	0